

ABB-Welcome

M22001-.

M22002-.

M22003-.

Audio handset indoor station



1	Safety	3
2	Intended use.....	3
3	Environment	3
3.1	ABB devices	4
4	Operations.....	5
4.1	Standard operations	5
4.1.1	Control elements	5
4.2	Settings.....	7
4.2.1	Ringtone type settings	7
4.2.2	Default outdoor station settings	7
4.2.3	Programming the auxiliary buttons	7
4.3	Adjusting the device.....	9
5	Technical data	11
6	Mounting / Installation.....	12
6.1	Requirements for the electrician	12
6.2	General installation instructions	13
6.3	Mounting.....	14

1 Safety



Warning

Electric voltage!

Risk of death and fire due to electrical voltage of 100-240 V.

- Work on the 100-240V supply system may only be performed by authorised electricians!
- Disconnect the mains power supply prior to installation and/or disassembly!

2 Intended use

The M2200x-x indoor station is an integral part of the ABB Welcome door entry system and operates exclusively with components from this system. The device must only be installed in dry indoor rooms.

3 Environment



Consider the protection of the environment!

Used electric and electronic devices must not be disposed of with domestic waste.

- The device contains valuable raw materials which can be recycled. Therefore, dispose of the device at the appropriate collecting depot.

3.1 ABB devices

All packaging materials and devices from ABB bear the markings and test seals for proper disposal. Always dispose of the packaging material and electric devices and their components via the authorized collecting depots and disposal companies.

ABB products meet the legal requirements, in particular the laws governing electronic and electrical devices and the REACH ordinance.

(EU-Directive 2002/96/EG WEEE and 2002/95/EG RoHS)

(EU-REACH ordinance and law for the implementation of the ordinance (EG) No.1907/2006)

4 Operations

4.1 Standard operations

4.1.1 Control elements

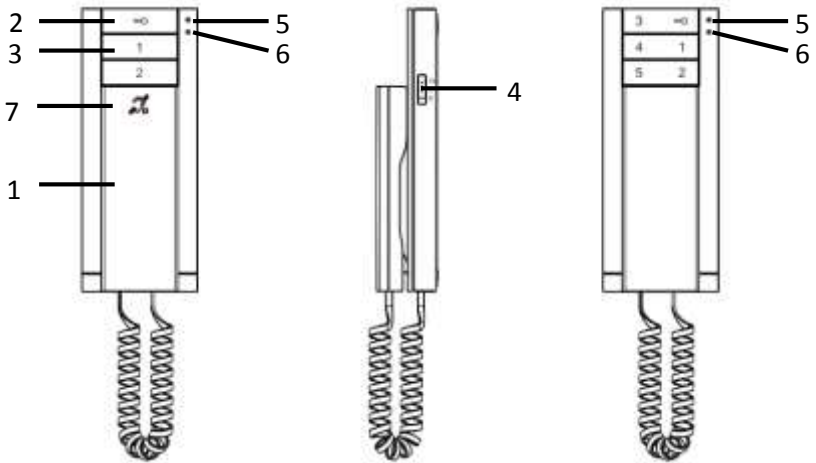







Fig. 1 Control elements

No.	Function
1	<p>Handset</p> <p>When a call is coming, pick up the handset to activate communication within 30 seconds and hang up the handset to end the call.</p>
2	<p>Unlock button</p> <p>2A Press this button to open the door at any time.</p> <p>2B auto-unlock: the door is automatically opened for an incoming call (hold this button for over 10 seconds until the blue LED turns on; the same operation will switch off the function and the blue LED will turn off).</p>
3	<p>Programmable button</p> <p>3A *Programmable for additional functions, e.g. call guard unit, intercom.....</p> <p>3B Default function of button 1 is the release of the lock connected with an outdoor station (COM-NC-NO).</p>
4	<p>Three-level selector for call volume adjustment (maximum/ medium / mute).</p>
5	<p>LED (Red)</p> <div style="display: flex; justify-content: space-around; align-items: flex-start;"> <div style="text-align: center;">  <p>- indicating that the door is open over the set time (The sensor must be connected)</p> </div> <div style="text-align: center;">  <p>- when any button is pressed.</p> </div> <div style="text-align: center;">  <p>- indicating mute.</p> </div> </div>
6	<p>LED (Blue)</p> <div style="display: flex; justify-content: space-around; align-items: flex-start;"> <div style="text-align: center;">  <p>- indicating that the system is busy.</p> </div> <div style="text-align: center;">  <p>- indicating an Incoming call.</p> </div> <div style="text-align: center;">  <p>- indicating auto-unlock.</p> </div> </div>
7	<p>**Induction loop function</p>

*For their use, please contact your electrical installer.

**This function is only available in M22003-.

4.2 Settings

4.2.1 Ringtone type settings

1. Hold " **1** + **2** " for about 3 seconds to enter the system setting mode (with blue LED & red LED flashing simultaneously).
2. Press **☰** to set the next ringtone type for the door bell.
3. Press **1** to set the next ringtone type for a call from an outdoor station.
4. Press **2** to set the next ringtone type for an intercom call from other apartments or the guard unit.
5. Hold " **1** + **2** " for about 3 seconds to save the selected ringtone type and exit the system setting mode..







4.2.2 Default outdoor station settings

1. Pickup the handset, hold **☰** for about 3 seconds to enter the default outdoor station setting mode.
2. Press **☰** button to set the address of the default outdoor station. (the value is indicated by the flash times of the red LED; it can be set from 1 to 9, default setting: 1).
3. Hold **☰** for about 3 seconds or put down the handset to save the setting and exit the settings mode.

4.2.3 Programming the auxiliary buttons

Each programmable button is available only after setting. These buttons can be set for different functions, e.g. call guard unit, intercom call or controls switch actuator.

1. Enter the programming mode
Hold the programmable button for 3 seconds in the standby mode to enter the programming mode.
2. Set the function for each programmable button
Check the needed function, and press **1** to program the corresponding function code which is indicated by the flash times of the blue LED.
 - The function code can be changed: 0->1->2->3->4->5->0.

Function list	Function code	Blue LED flashing
No function	0	 Always on
Control switch actuator	1	 Flash once
Intercom call in the same apartment	2	 Flash twice
Intercom call among different apartments	3	 Flash 3 time
Call guard unit	4	 Flash 4 time
Release 2nd-lock of a default outdoor station (the lock connected with an outdoor station COM-NC-NO)	5	 Flash 5 time

Function code is indicated by flash times of blue LED; if the Blue LED is always on, this represents code 0.

3. Set the address for each programmable button

Only the following two functions are assigned to the programmable buttons, The address of each programmable button is needed to be set. Other functions are inapplicable to this step.



Function 1: Controls switch actuator. Set the address of the switch actuator under control. The address can be set from 01 to 99.

Function 2: Intercom call among different apartments. Set the address of an indoor station which is called. The address can be set from 01 to 99.

Hold this programmable button again for 3 seconds until the LED begins to flash (tens digit or units digit address is other than 0) or lights on (tens digit or units digit address is 0) to enter the address settings mode.

Press  repeatedly to set the tens digit. Each press means one increment to the previous address. The value is indicated by the flash times of the red LED.

Press  repeatedly to set the units digit in the same manner. The value is indicated by the flash times of the blue LED.

Both tens digit and units digit can be changed in a sequence of: 0->1->2->3->4->5->6->7->8->9->0 by pressing  or .

During settings, if the value set is beyond the wanted number, press 2, both tens digit and units digit will go back to the default value 0.

4. Exit the programming mode
Hold this programmable button for 3 seconds until the blue LED & red LED flash once simultaneously.

4.3 Adjusting the device

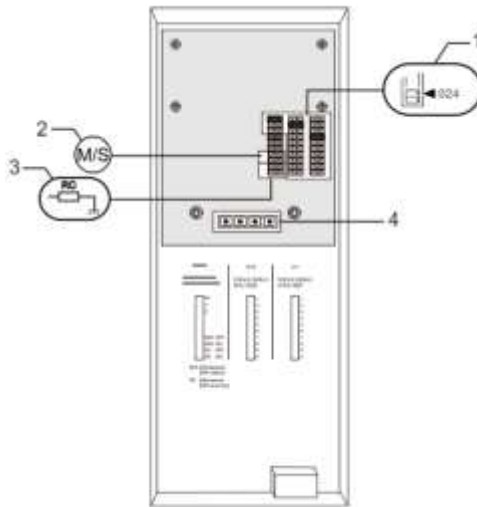

Fig. 2:

1. X100 X10 X1

Jumper to set the address of the indoor station.

EXAMPLE: setting address 024

2. Master /Slave function

Only one indoor station in each apartment must be set as "Master" (Jumper should

be set as 'M/S on'). All additional indoor stations in the same apartment must be set as "Slave" (Jumper should be set as 'M/S off').

3. Terminal resistor

In video installations or mixed audio and video installations, the Jumper must be set as 'RC on' on the last device of the line.

4. a b = Bus connection



= Door bell connection

5 Technical data

Designation	Value
Operating temperature	-10° C – +55° C
Storage temperature	-40° C – +70° C
Protection	IP 30
Single-wire clamps	2 x 0.28 mm ² – 2 x 1 mm ²
Fine-wire clamps	2 x 0.28 mm ² – 2 x 1 mm ²
Bus voltage	20-30 V

6 Mounting / Installation



Warning

Electric voltage!

Risk of death and fire due to electrical voltage of 100-240 V.

- Low-voltage and 100-240 V cables must not be installed together in a flush-mounted socket!

In case of a short-circuit there is the danger of a 100-240 V load on the low-voltage line.

6.1 Requirements for the electrician



Warning

Electric voltage!

Install the device only if you have the necessary electrical engineering knowledge and experience.

- Incorrect installation endangers your life and that of the user of the electrical system.
- Incorrect installation can cause serious damage to property, e.g. due to fire.

The minimum necessary expert knowledge and requirements for the installation are as follows:

- Apply the "five safety rules" (DIN VDE 0105, EN 50110):
 1. Disconnect from power;
 2. Secure against being re-connected;
 3. Ensure there is no voltage;
 4. Connect to earth;
 5. Cover or barricade adjacent live parts.

- Use suitable personal protective clothing.
- Use only suitable tools and measuring devices.
- Check the type supply network (TN system, IT system, TT system) to secure the following power supply conditions (classic connection to ground, protective earthing, necessary additional measures, etc.).

6.2 General installation instructions

- Terminate all branches of the wiring system via a connected bus device (e.g., indoor station, outdoor station, system device).
- Do not install the system controller directly next to the bell transformer and other power supplies (to avoid interference).
- Do not install the wires of the system bus together with 100-240 V wires.
- Do not use common cables for the connecting wires of the door openers and wires of the system bus.
- Avoid bridges between different cable types.
- Use only two wires for the system bus in a four-core or multi-core cable.
- When looping, never install the incoming and outgoing bus inside the same cable.
- Never install the internal and external bus inside the same cable.

6.3 Mounting

Recommended installation height

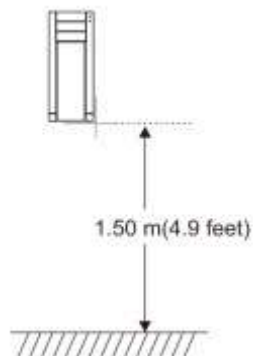

Dismantling

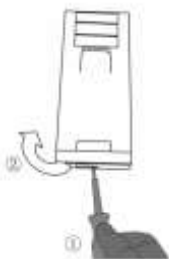

Pull the clamp on the bottom of the device and then open the housing of the panel.

Installation dimensions for slotted screw holes

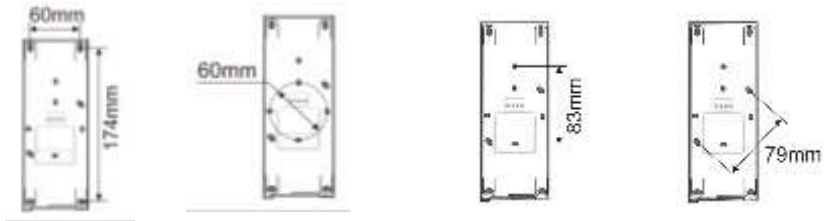

1. The bottom of the device has screw holes for fastening on the wall according to the above dimension instructions.
2. In addition, the bottom of the device can be fixed to the existing flush-mounted box. The dimension of the compatible flush-mounted box is shown above.

Wiring

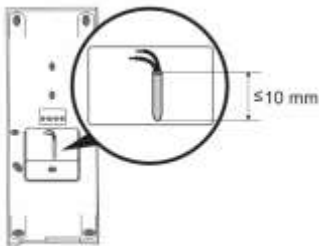

Fix the bottom of the device and connect it with reference to the graphics. The insulated section of the cable end must not be longer than 10mm.

Settings

Set addresses for the preferred outdoor stations and the address for the indoor station on the jumper (see chapter “ [Adjusting the device](#) ”).

Mounted on the wall

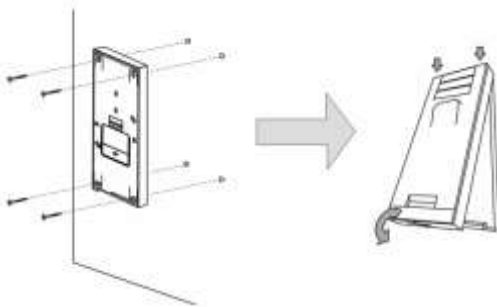

1. Fix the bottom of the device to the wall.
2. Latch the upper part of the device onto its bottom part: place the upper side of the device on the lock-in lugs and then press the bottom side onto the bottom part of the device until it is caught by the clamp.

Mounted with flush-mounted box

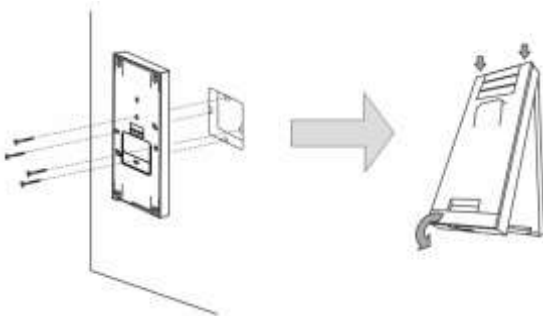

1. Fix the bottom of the device to the existing flush-mounted box.
2. Latch the upper part of the device onto its bottom part: place the upper side of the device on the lock-in lugs and then press the bottom side onto the bottom part of the device until it is caught by the clamp.

The installation of the indoor station is now complete.

Notice

We reserve the right to at all times make technical changes as well as changes in the contents of this document without prior notice.

The detailed specifications agreed to at the time of ordering apply to all orders. ABB accepts no responsibility for possible errors or incompleteness in this document.

We reserve all rights to this document and the topics and illustrations contained therein. The document and its contents, or extracts thereof, must not be reproduced, transmitted or reused by third parties without prior written consent by ABB.