

# C1900

## Circular chart recorder/controller



Multi-recipe profile controller versions

Measurement made easy

—  
C1900  
circular chart  
recorder/controller

### For more information

Further publications are available for free download from:

[www.abb.com/recorders](http://www.abb.com/recorders)

or by scanning this code:



#### Search for or click on

Data Sheet C1900 Circular chart recorder/controller	<a href="#">DS/C1900RC-EN</a>
Quick Reference Guide Circular chart recorder/controller	<a href="#">IM/C1900-QC</a>
Installation Guide C1900 Circular chart recorder and recorder/controller	<a href="#">IM/C1900-INS</a>
Operating Guide C1900 Circular chart recorder/controller	<a href="#">IM/C1900-OGC</a>
Programming Guide C1900 Circular chart recorder/controller	<a href="#">IM/C1900-PGC</a>
Operating Instructions C1900 Circular chart recorder and recorder/controller	<a href="#">IM/C1900-MOD</a>

## Electrical safety

This equipment complies with the requirements of CEI/IEC 61010-1:2001-2 'Safety Requirements for Electrical Equipment for Measurement, Control and Laboratory Use'. If the equipment is used in a manner NOT specified by the Company, the protection provided by the equipment may be impaired.

## Symbols

One or more of the following symbols may appear on the equipment labelling:



**Warning** – refer to the manual for instructions



**Caution** – risk of electric shock



Protective earth (ground) terminal



Earth (ground) terminal



Direct current supply only



Alternating current supply only



Both direct and alternating current supply



The equipment is protected through double insulation

---

Information in this manual is intended only to assist our customers in the efficient operation of our equipment. Use of this manual for any other purpose is specifically prohibited and its contents are not to be reproduced in full or part without prior approval of the Technical Publications Department.

## Health and safety

To ensure that our products are safe and without risk to health, the following points must be noted:

- The relevant sections of these instructions must be read carefully before proceeding.
- Warning labels on containers and packages must be observed.
- Installation, operation, maintenance and servicing must only be carried out by suitably trained personnel and in accordance with the information given.
- Normal safety precautions must be taken to avoid the possibility of an accident occurring when operating in conditions of high pressure and/or temperature.
- Chemicals must be stored away from heat, protected from temperature extremes and powders kept dry. Normal safe handling procedures must be used.
- When disposing of chemicals ensure that no two chemicals are mixed.

Safety advice concerning the use of the equipment described in this manual or any relevant hazard data sheets (where applicable) may be obtained from the Company address on the back cover, together with servicing and spares information.

---

# CONTENTS

---

Section	Page
<b>1 INTRODUCTION .....</b>	<b>2</b>
1.1 Multi-recipe Profile Control Models .....	2
1.1.1 Type K Retort Controller Models .....	2
1.1.2 Type L Advanced Profile Control Models .....	2
<b>2 DISPLAYS AND CONTROLS .....</b>	<b>3</b>
2.1 Type K Instrument Displays and LED Indicators .....	3
2.2 Type L Instrument Displays and LED Indicators .....	3
2.3 Faceplate Combinations and Product Codes .....	4
<b>3 ELECTRICAL INSTALLATION .....</b>	<b>5</b>
3.1 Identifying the Input/Output Modules (and accessing the Configuration Levels) .....	5
3.2 Standard Connections .....	5
<b>4 CONTROL CONFIGURATION LEVEL .....</b>	<b>6</b>
4.1 Control Configuration Level .....	6
4.2 Introduction to Ramp/Soak Profile Control .....	7
4.2.1 Program Configurations .....	7
4.2.2 Guaranteed Ramp/Soak .....	8
4.2.3 Power Recovery Function .....	8
4.2.4 Self-seeking Set Point .....	9
4.2.5 Retort Function .....	9
4.2.6 Time Events .....	10
4.2.7 Profile Start and End States .....	10
4.3 Soak Adjustment – Type K Instruments .....	10
4.3.1 Cook Segment Soak Adjustment .....	10
4.3.2 Current Segment Soak Time Adjustment .....	11
4.4 Soak Adjustment – L Type Instruments .....	12
4.4.1 Current Segment Soak Time Adjustment .....	12
4.5 Ramp/Soak Profile Control .....	13
4.6 Ramp/Soak Profile Program .....	17
<b>5 ADVANCED CONFIGURATION LEVEL .....</b>	<b>20</b>
5.1 Advanced Configuration Level .....	20
5.2 Timer .....	21
5.2.1 Set Up Timer .....	21
5.2.2 Set Up Clock .....	24

# 1 INTRODUCTION

The COMMANDER 1960 Series documentation is shown in Fig. 1.1.

This supplement provides additional information for Ramp/Soak Control and details four Profile Control variants within the COMMANDER 1900 range. It must be read in conjunction with the standard COMMANDER 1900 Controller documentation.

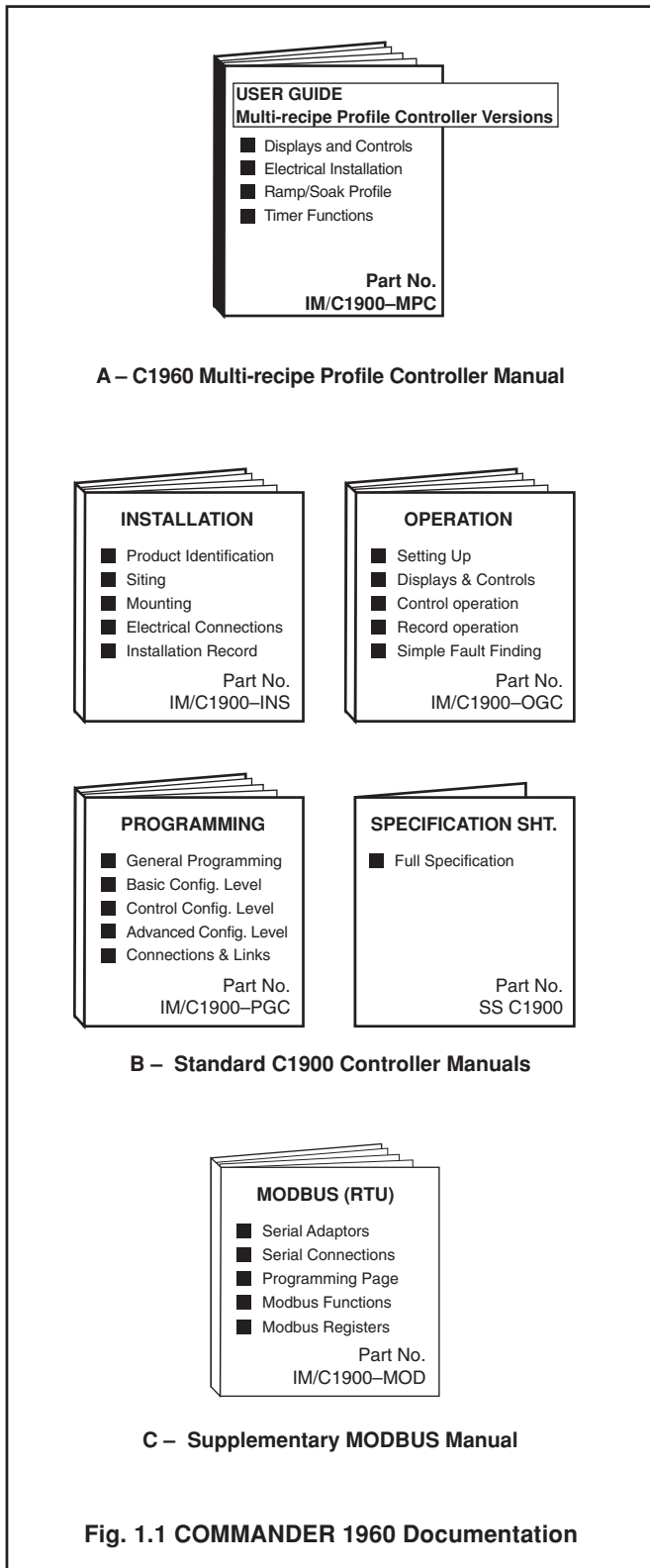

## 1.1 Multi-recipe Profile Control Models

The COMMANDER 1960 Profile Controller is a development of the COMMANDER 1900, incorporating advanced Ramp/Soak profiling capabilities.

There are four models in the series:

1961R	single pen, single loop ramp/soak control
1962R	two pen, single loop ramp/soak control
1963R	three pen, single loop ramp/soak control
1964R	two pen, dual loop ramp/soak control

Each model is available with a choice of software providing additional specialized features.

### 1.1.1 Type K Retort Controller Models

- Front panel adjustment of principal soak temperature and soak time.
- Continuous display of principal soak temperature, soak time and current segment number.
- LED indication of whether ramp or soak is being performed.
- LED indication of profile status.
- 6 time-event states common to all segments.
- Guaranteed ramp/soak by segment.

### 1.1.2 Type L Advanced Profile Control Models

- Front panel adjustment of the current soak time.
- Continuous display of level (soak segments) or target set point (ramping segments).
- Continuous display of time remaining in current segment.
- Continuous display of current segment number.
- LED indication of whether ramp or soak is being performed.
- LED indication of profile status.
- 6 time-event states common to all segments.
- Guaranteed ramp/soak by segment.

## 2 DISPLAYS AND CONTROLS

### 2.1 Type K Instrument Displays and LED Indicators – Fig. 2.1 and 2.2

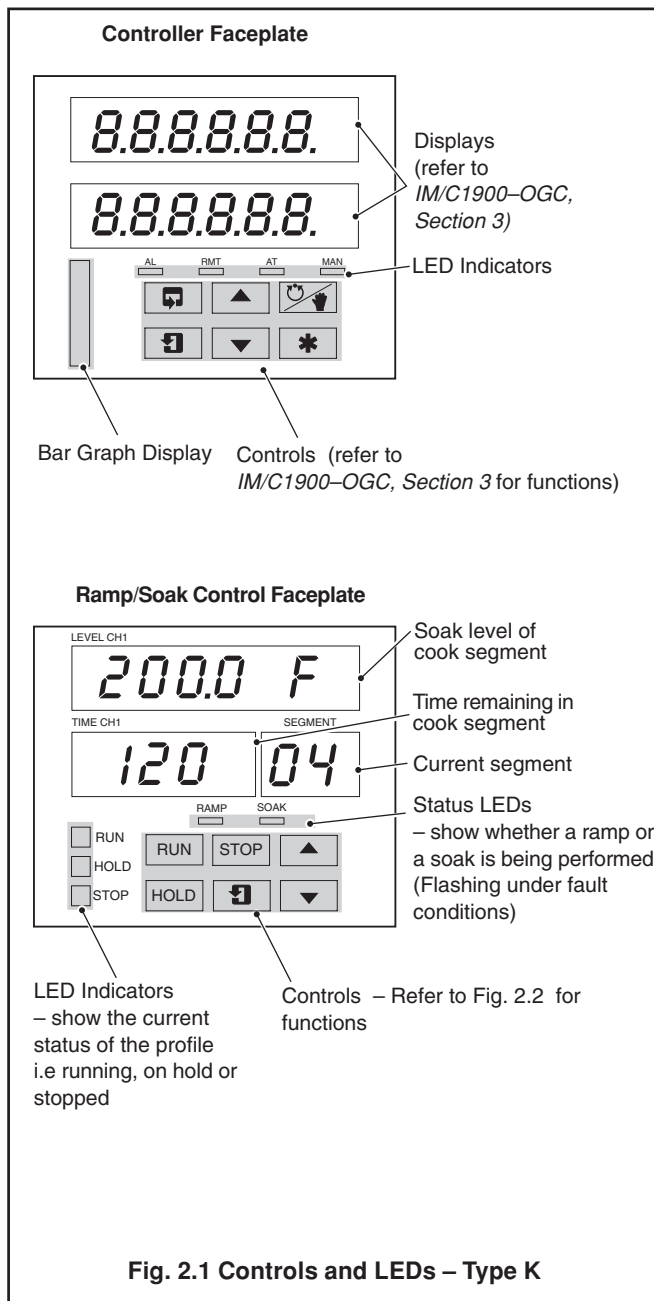

### 2.2 Type L Instrument Displays and LED Indicators – Fig. 2.3 and 2.4

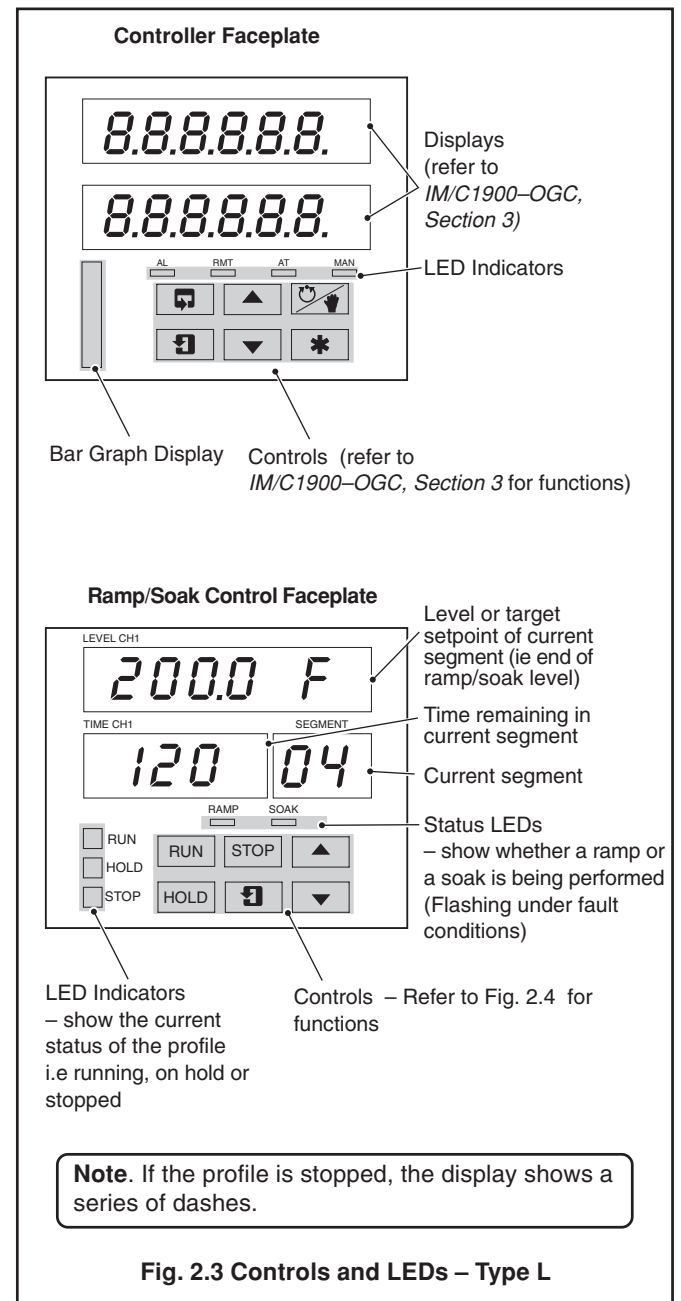

- |                               |  |
|-------------------------------|--|
| <input type="checkbox"/> RUN  | Start the profile running                          |
| <input type="checkbox"/> HOLD | Hold (pause) the profile                           |
| <input type="checkbox"/> STOP | Stop and reset the profile                         |
| ▲                             | Increment soak time/soak level                     |
| ▼                             | Decrement soak time/soak level                     |
| ⏏                             | Select between soak level and soak time adjustment |

**Fig. 2.2 Switch Functions – Type K**

- |                               |                                     |
|-------------------------------|-------------------------------------|
| <input type="checkbox"/> RUN  | Start the profile running           |
| <input type="checkbox"/> HOLD | Hold (pause) the profile            |
| <input type="checkbox"/> STOP | Stop and reset the profile          |
| ▲                             | Increment current segment soak time |
| ▼                             | Decrement current segment soak time |
| ⏏                             | Not used                            |

**Fig. 2.4 Switch Functions – Type L**

## ...2 DISPLAYS AND CONTROLS

### 2.3 Faceplate Combinations and Product Codes – Fig. 2.5

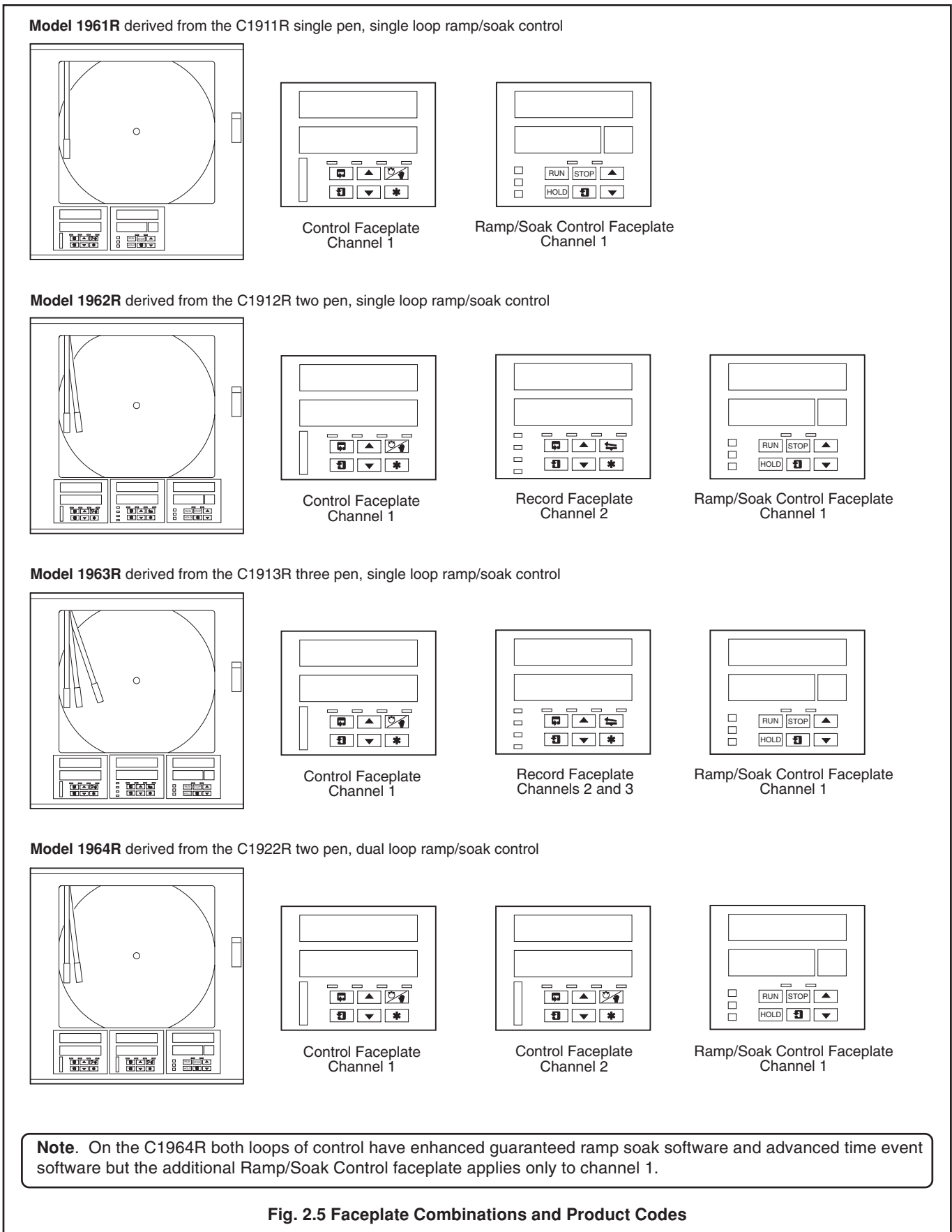

### 3 ELECTRICAL INSTALLATION

#### 3.1 Identifying the Input/Output Modules (and accessing the Configuration Levels) – Fig. 3.1

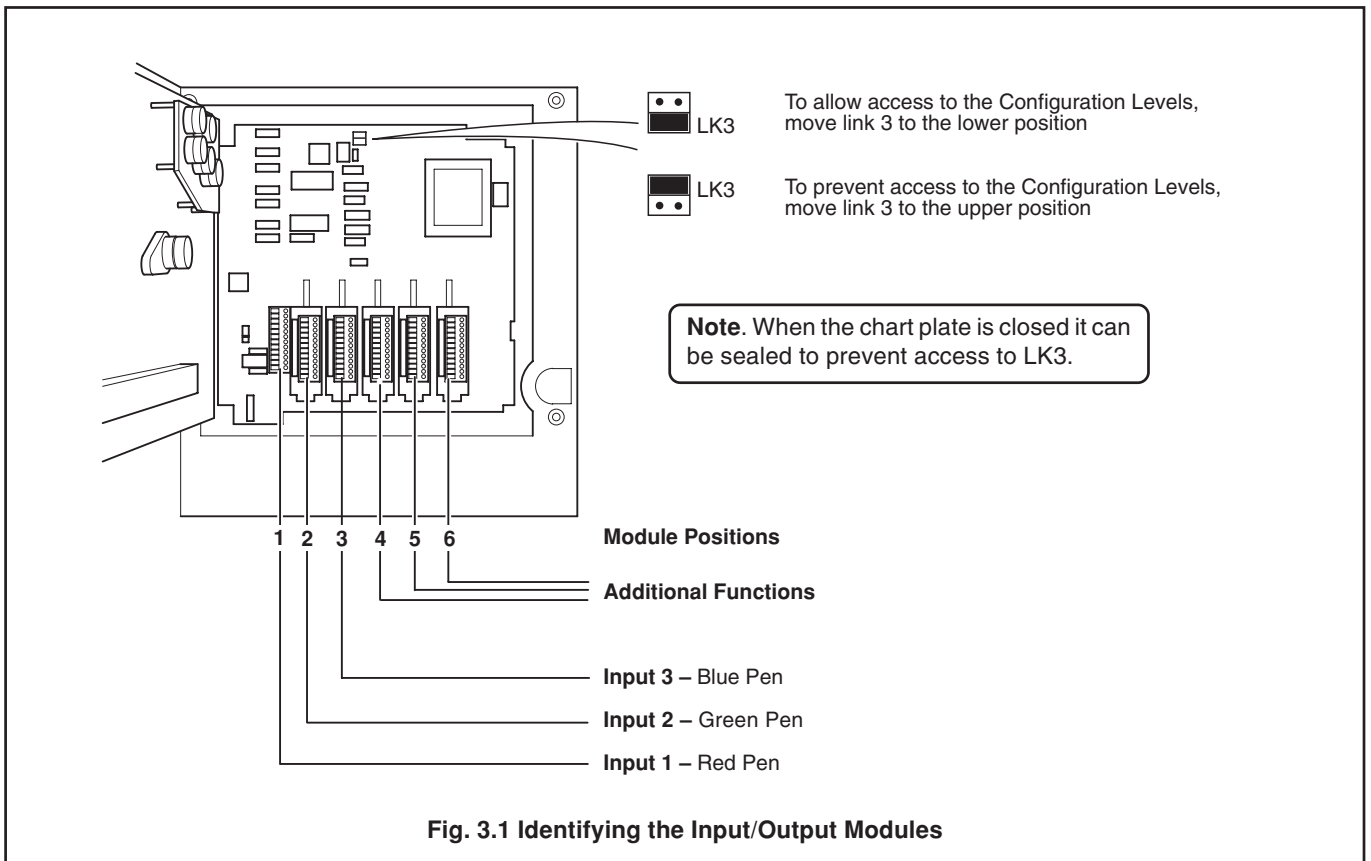

#### 3.2 Standard Connections

Refer to *IM/C1900-INS, Section 4.2* for input connections.

# 4 CONTROL CONFIGURATION LEVEL

## 4.1 Control Configuration Level – Fig. 4.1

The general content of the Control Configuration Level is detailed in *IM/C1900-PGC, Section 3*. Any changed or additional frames are detailed in Sections 4.5 and 4.6 of this manual.

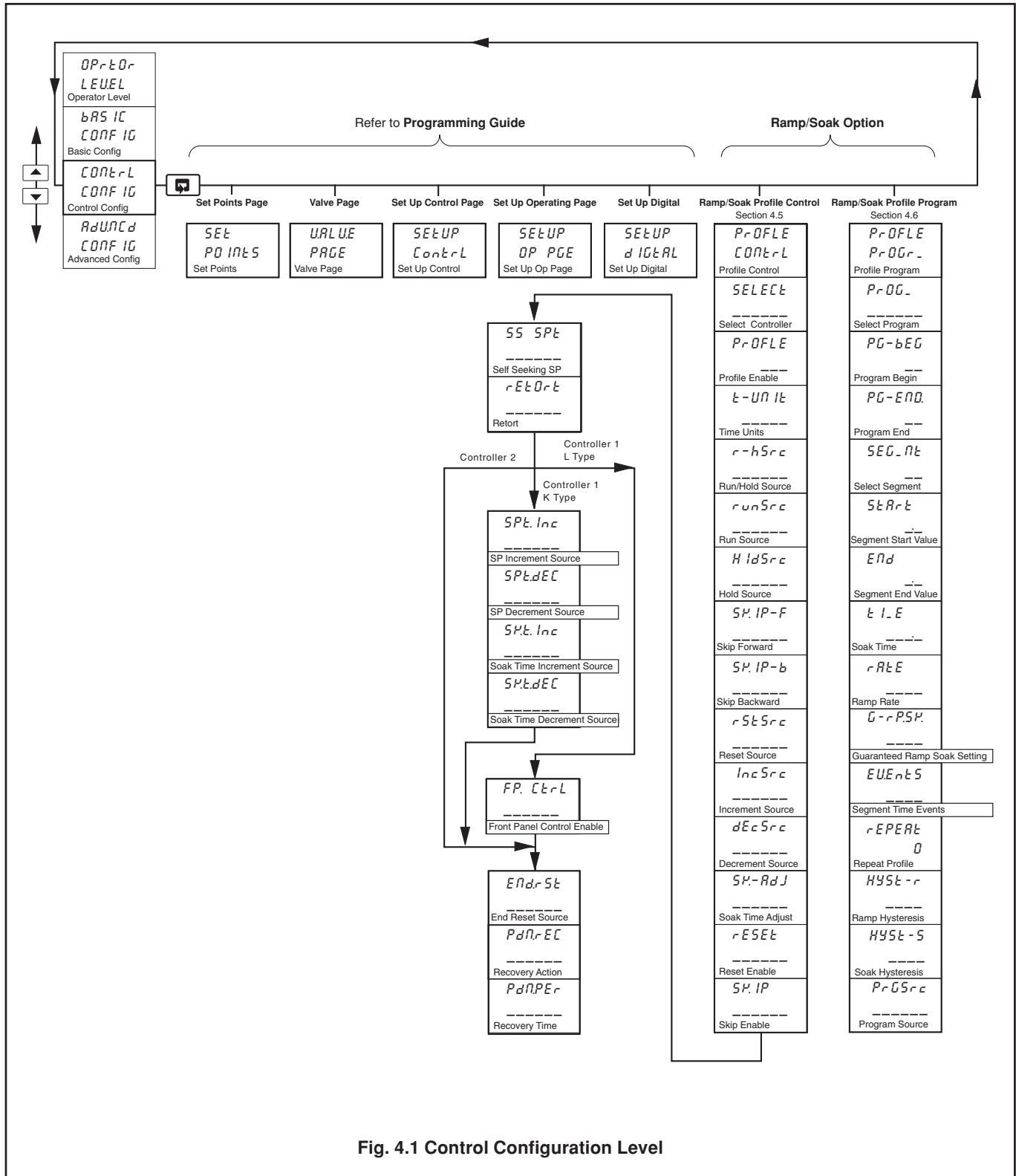

Fig. 4.1 Control Configuration Level



4.2 Introduction to Ramp/Soak Profile Control

Information.

- **10 programs per control channel.**
- **Digital State program selection** – allows digital inputs to select program to be run.
- **99 programmable segments** – can be shared between programs and controllers – see Fig. 4.2.
- **Programmable time units** – can be programmed in hours or minutes.
- **Program repeat** – 0 to 99 times or continuously.
- **Program holdback hysteresis** – separate settings for ramping segments and soak segments.  
– can be applied above, below or above and below the set point.
- **6 types of ramp/soak generated events** – segment active event, program active event, end of program event, holdback event, hold active event and time events.
- **6 ramp/soak commands** – can be selected from the front panel or via digital signals to run/hold programs, reset programs, skip forward to next segment, skip backwards to beginning of segment, increase soak time or decrease soak time (refer to Figs. 4.7 to 4.10 for ramp/soak adjust example).
- **6 time event states** – common to each segment
- **Self-seeking set point function** – avoids unnecessary delays when a program is started – see Fig. 4.4.
- **Retort function** – ensures safe operation under fault conditions – see Fig. 4.5.
- **Power recovery function** – determines ramp/soak profile restart position.
- **End of Profile State** – latched ‘ON’ until reset

The Ramp/Soak option is a set point profile generator which controls the Local set point and can be used with any type of control process for more complex control. A Profile Program is made up of Ramps (the set point is increased or decreased at a linear rate until it reaches the desired value) and Soaks (the set point is maintained at a fixed value for a set time duration).

4.2.1 Program Configurations – Fig. 4.2

There are 99 segments that can be shared between programs and control channels. For normal applications it is recommended that segments 1 to 50 are assigned to channel 1 and segments 51 to 99 are assigned to channel 2. Fig. 4.2 shows 8 segments, shared between two separate programs on channel 1.

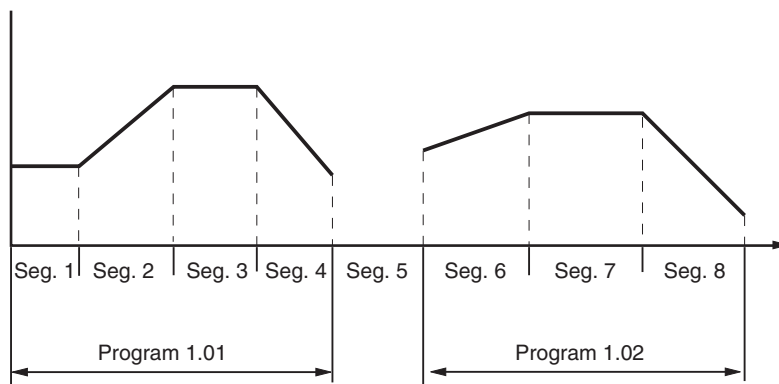

Fig 4.2 Program Configurations

## ...4 CONTROL CONFIGURATION LEVEL

### 4.2.2 Guaranteed Ramp/Soak

If the process variable deviates from the set point by more than the hysteresis value, the program status is set to 'H-HOLD' and Guaranteed ramp/soak is applied automatically. Each program has two associated hysteresis values;

- HYSL-r* which is applied to ramping segments, and
- HYSL-S* which is applied to soak segments.

The hysteresis value can be set within the limits '0' to '9999' where a setting of '0' implies that no deviation from the set point value can be tolerated ('0' is the company standard setting).

Hysteresis can be applied in one of four ways, with individual settings for each segment;

- OFF* – hysteresis not applied, ramp/soak not guaranteed.
- HI* – hysteresis applied above set point ( 'H-HOLD' set if  $PV > [SP + \text{Hysteresis}]$ ).
- LO* – hysteresis applied below set point ( 'H-HOLD' set if  $PV < [SP - \text{Hysteresis}]$ ).
- HI-LO* – hysteresis applied above and below set point ( 'H-HOLD' set if  $PV > [SP + \text{Hysteresis}]$  or  $PV < [SP - \text{Hysteresis}]$ ).

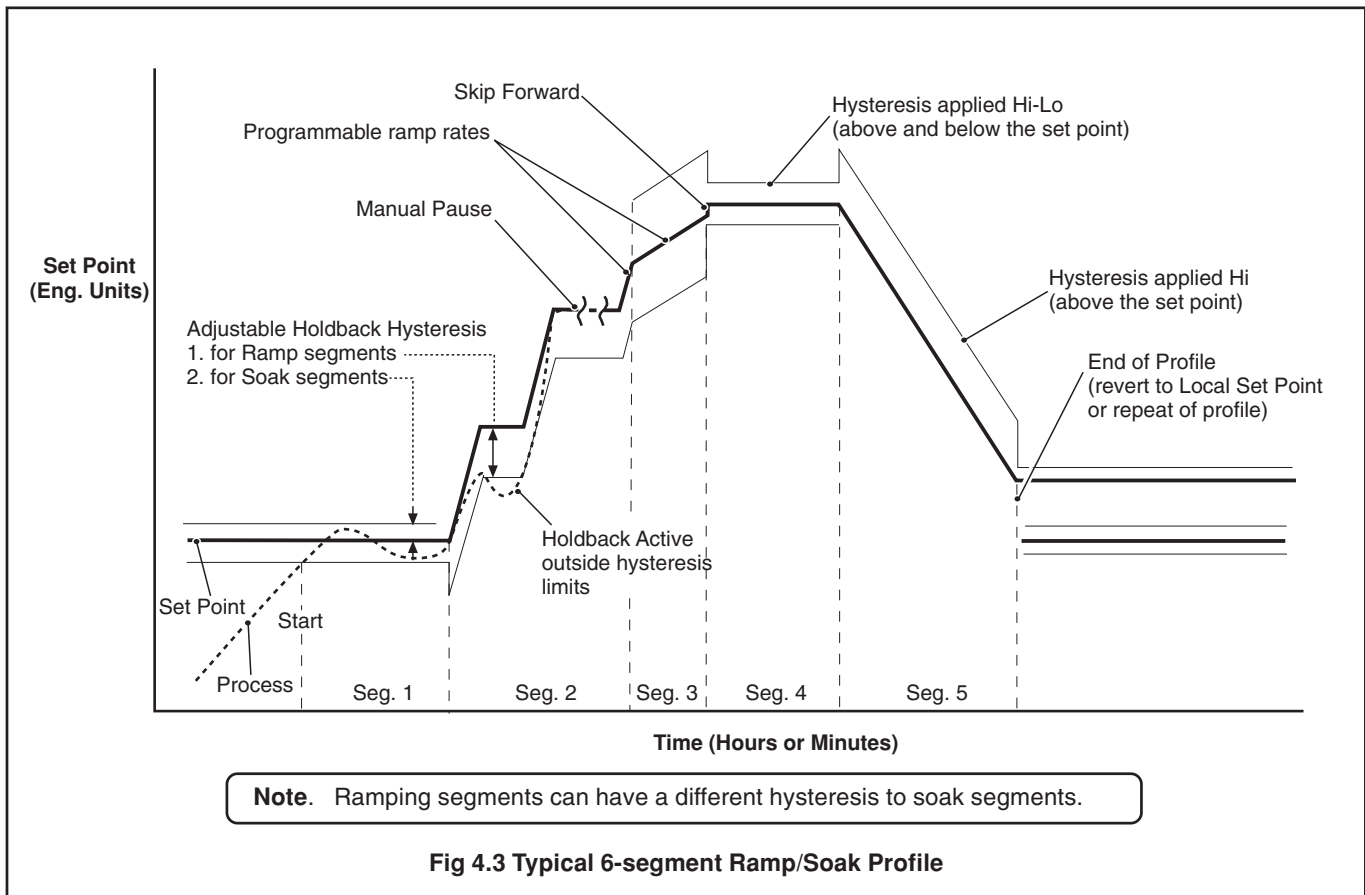

### 4.2.3 Power Recovery Function

The Power Recovery function allows pre-selection of the restart position within a ramp/soak profile when power is restored after a failure. If power is restored before the **Power Down Time** expires, the ramp/soak profile continues from the point at which power failed. If power is restored after the **Power Down Time** has expired, the profile resumes from one of the following user-selected points: start of the current program; start of the current segment or from the profile position at the time of failure. In all three cases the controller restarts in **HOLD** mode.

4.2.4 Self-seeking Set Point – Fig. 4.4

The Self-seeking Set Point function reduces the delay between the end of a program and the beginning of the next program. The process variable value is used as the program start point and the set point steps up to the process variable value. This has the effect of changing the overall segment time and maintains a constant ramp rate.

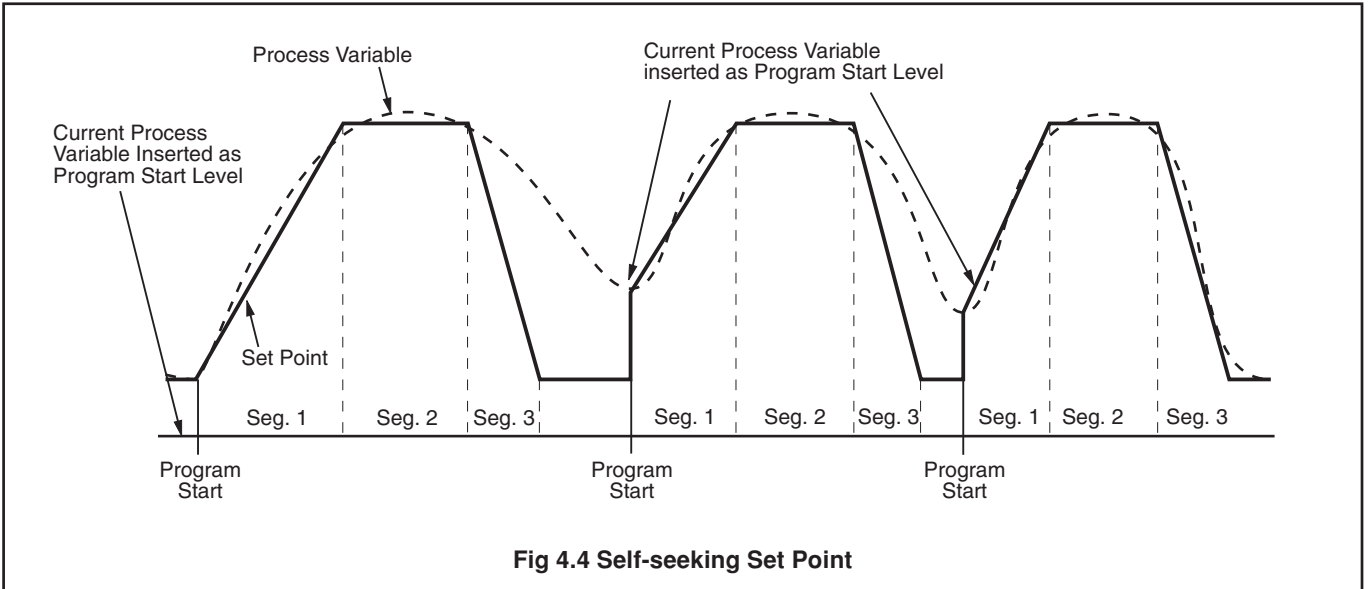

4.2.5 Retort Function – Fig. 4.5

The Retort function ensures safe operation of retort vessels under fault conditions. If the heat source fails during a soak segment, the process variable will inevitably fall. When the process variable falls below the holdback hysteresis value the program is put on HOLD (as for normal operation). The setpoint then follows the process variable as it continues to fall (Retort Hold).

Setpoint = Process Variable + Hysteresis value

Upon recovery of the heat source, the process is controlled at the new setpoint value. When the process variable reaches the setpoint it is then ramped back to the initial soak value at the rate of the previous ramp (Retort Ramp). When the soak level is reached the program is released from its hold state and the segment is either completed or repeated from the beginning, depending on the retort mode selected.

The retort mode is selected in the **Ramp/Soak Profile Page, CONTROL CONFIGURATION LEVEL.**

**Note.** For the retort function to operate, either LO or HI-LO hysteresis must be applied to the soak segments.

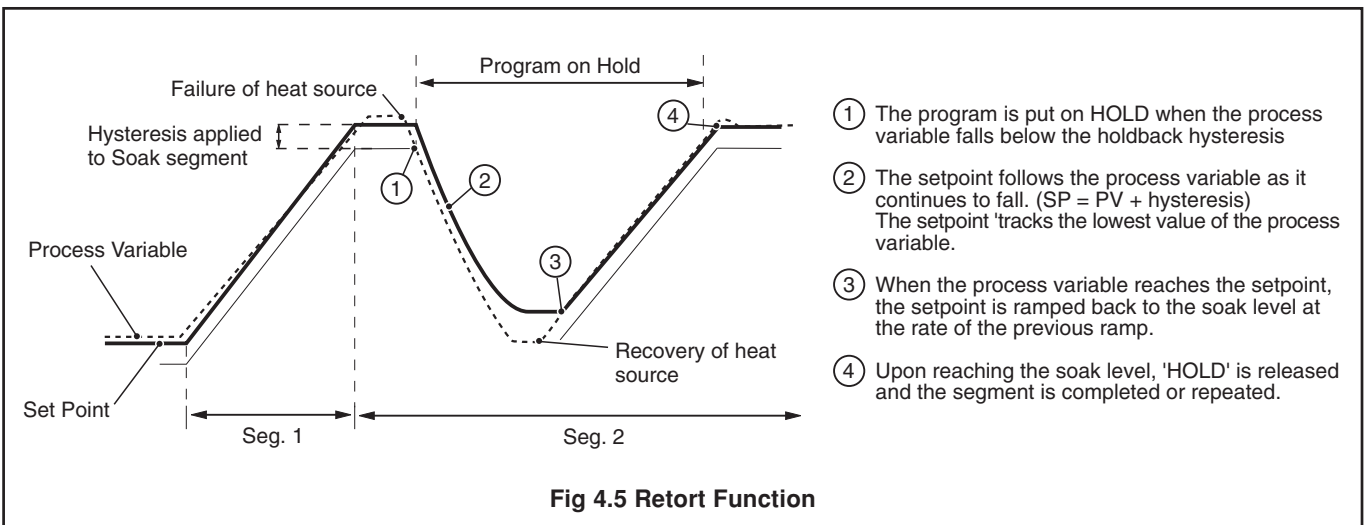

## ...4 CONTROL CONFIGURATION LEVEL

### 4.2.6 Time Events – Fig. 4.6

Channel 1 and 2 can be assigned up to six Time-event states. Each state generates a source ('*TEU-1.1*' to '*TEU-5.1*' and '*TEU-1.2*' to '*TEU-5.2*') which can be assigned to relays, digital outputs, logic equations etc. in the same way as any other digital signal. Time event states are provided in addition to program and segment events states and do not affect their operation. Each segment has an associated '*EVENTS*' setting which is used to control the Time-event states.

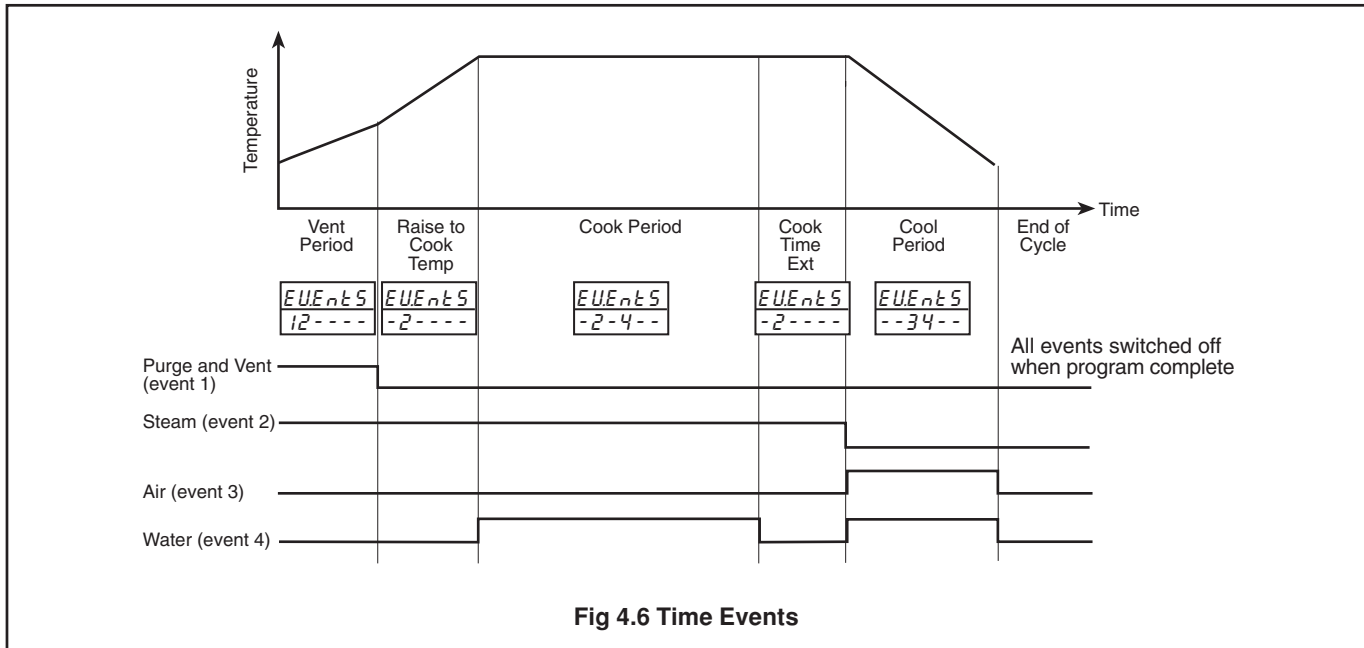

### 4.2.7 Profile Start and End States

A profile can be started in one of three ways:

- From the dedicated front panel switch – see Figs. 2.1 to 2.4
- internal edge-triggered Program Run Source – see Section 4.5
- internal level-triggered Program Run/Hold Source – see Section 4.5

The 'end of profile' state is set automatically when the program ends and remains set until a reset signal is received. The end of profile reset signal can be configured as any digital source – see Section 4.5/ Table 4.1. If no digital signal is selected as the end of profile reset source then the end of profile state resets automatically after two seconds.

#### Note.

The value of the control set point on completion of a profile is determined by the method used to start the profile:

- If the front panel switch or edge-triggered 'program run source' are used to run a profile, on completion the control set point resets automatically to the profile start value, awaiting the next start signal.
- If the level-triggered 'program run/hold source' is used to run a program, on program completion, the control set point is held at the profile end value until the program run/hold source is set to 'hold', at which point the control set point is set to the profile start value.

## 4.3 Soak Adjustment – Type K Instruments

### 4.3.1 Cook Segment Soak Adjustment (Control Channel 1 only) – Fig. 4.8

The cook segment is defined as the soak segment with the highest soak level or the last segment in a series if more than one segment has this level (ie. the highest segment number).

The level and/or duration of the cook segment can be adjusted continuously, either by use of the keys on the Ramp/Soak control faceplate – see Fig. 2.1, or via digital signals – see **Ramp/Soak Profile Control Page**. The adjustment can be activated at any time during the program.

The Ramp/Soak control faceplate displays the time remaining in the cook segment. Initially, this is the segment duration, and it decrements to zero as the segment is being run. After the cook segment is completed, the display remains at zero until the end of the program, when it reverts back to the show segment duration. If several segments with the same soak level are cascaded, the time displayed is the total time for all these segments. Adjustments made to the soak level change the level of all these segments. Adjustments made to the soak time change the duration of the last segment only.

...4.3.1 Cook Segment Soak Adjustment (Control Channel 1 only) – Fig.4.8

**Note.** Any changes made to the cook time/temperature are saved in the program memory.

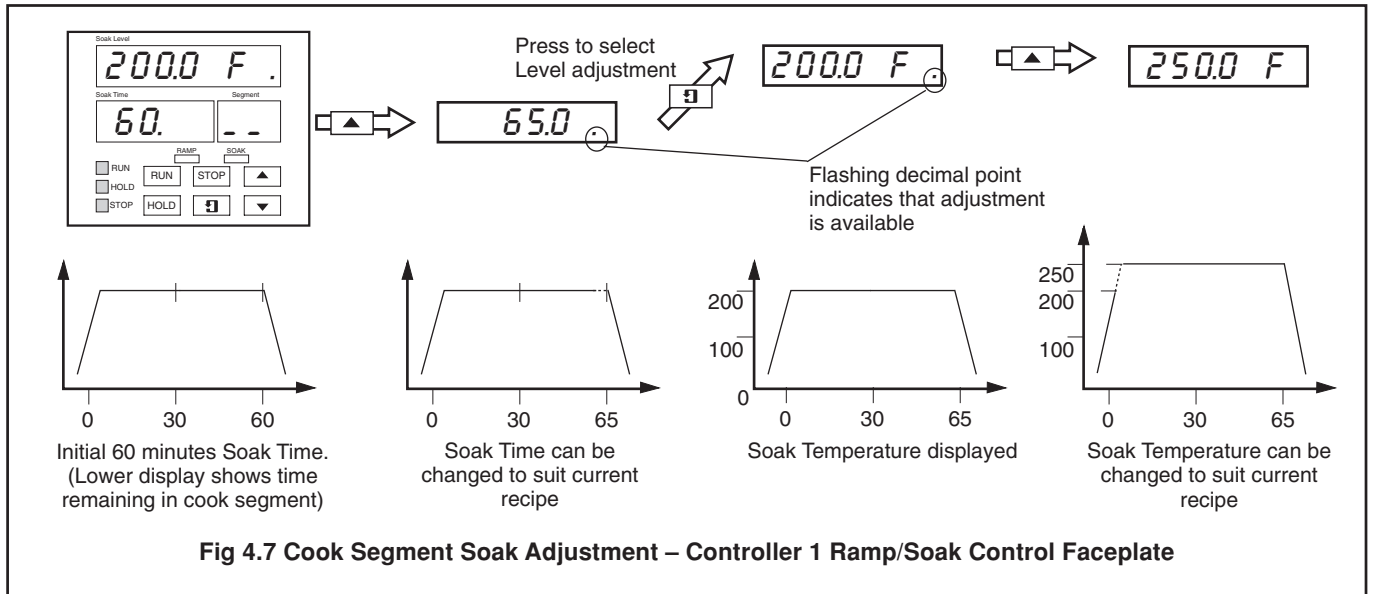

4.3.2 Current Segment Soak Time Adjustment (Control Channels 1 or 2) – Fig. 4.7

The Soak Adjust function allows the Soak time of a segment to be extended or reduced by a value preset in the 'SK-Adj' frame – see Ramp/Soak Profile Control Page. The soak time can be adjusted repeatedly (in preset increments) while the segment is running, either from the controller faceplate or by a digital signal (assigned in the 'Inc.Src' or 'dEc.Src' frames).

**Note.** Any changes made to the soak time via the controller faceplate are not saved in the program memory. At the end of the program, all soak times are reset to their original values.

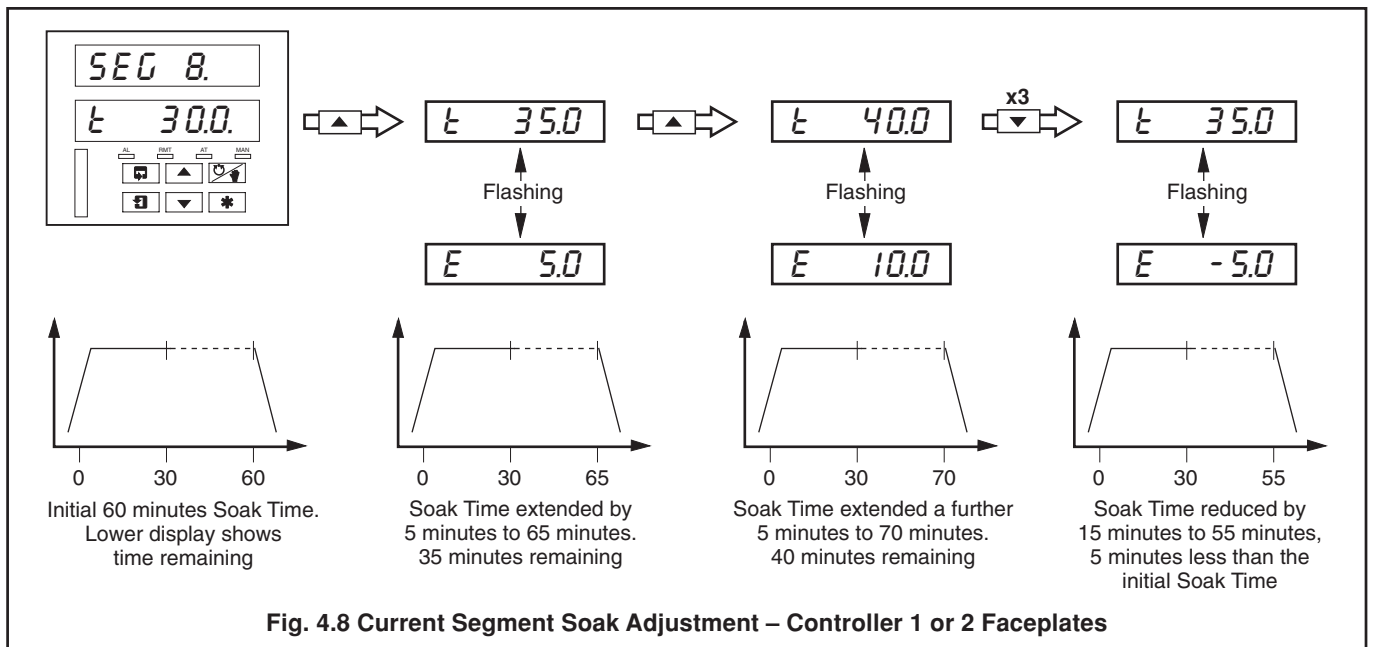

## ...4 CONTROL CONFIGURATION LEVEL

### 4.4 Soak Adjustment – L Type Instruments

#### 4.4.1 Current Segment Soak Time Adjustment – Figs. 4.9 and 4.10

The Soak Adjust function allows the Soak time of a segment to be extended or reduced by a value preset in the 'SK-Adj' frame – see **Ramp/Soak Profile Control Page**. The soak time can be adjusted repeatedly (in preset increments) while the segment is running, either from the Ramp/Soak control faceplate, the Controller faceplate or by a digital signal (assigned in the 'Inc.Src' or 'dEc.Src' frames).

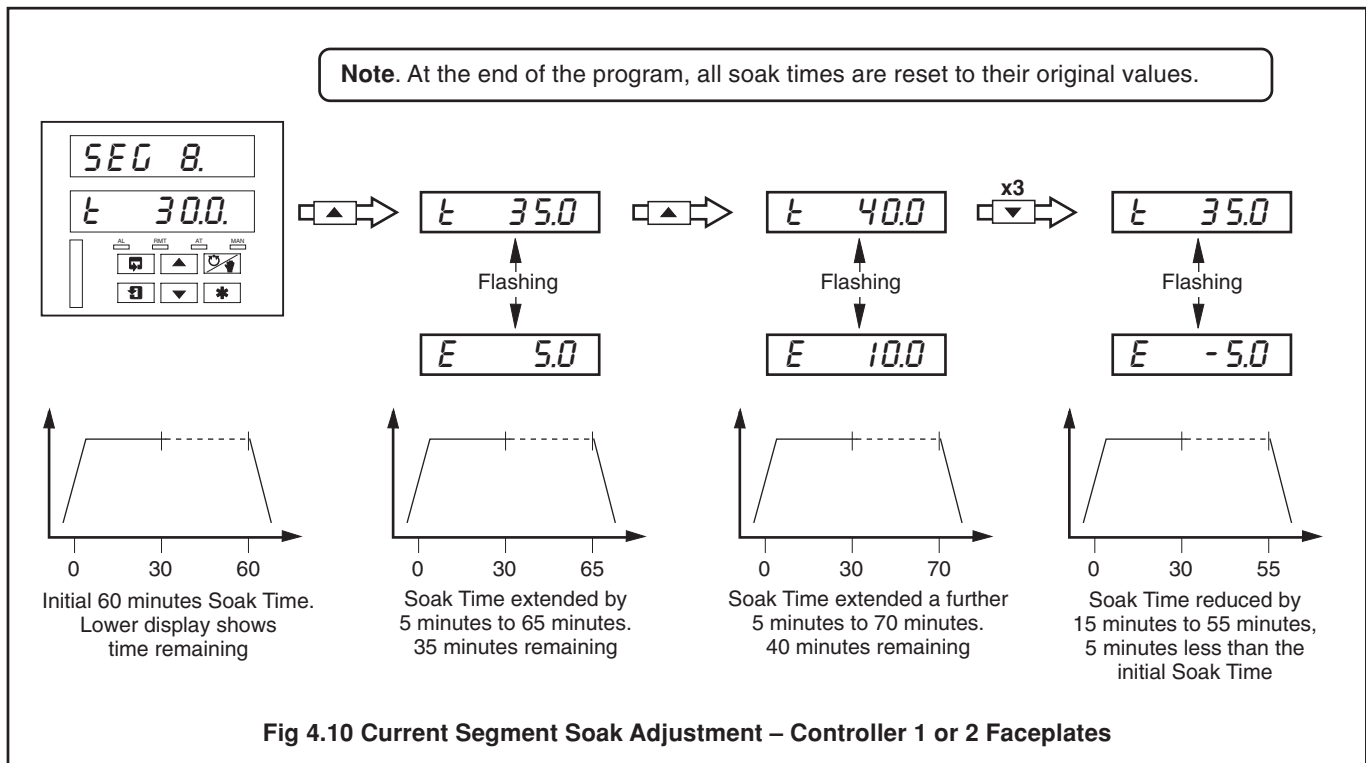
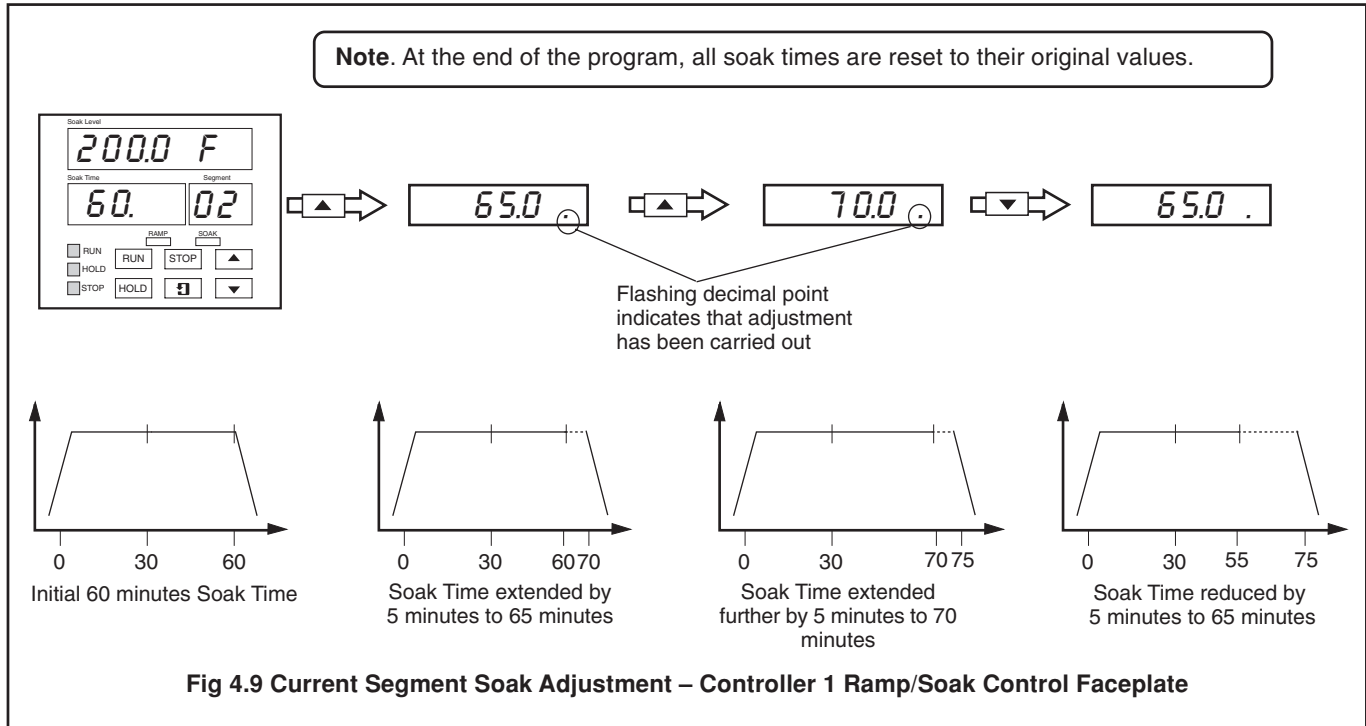

4.5 Ramp/Soak Profile Control

In this Section, parameters in the lower display denoted ■ are Company Standard Settings. The instrument is dispatched programmed with these settings.

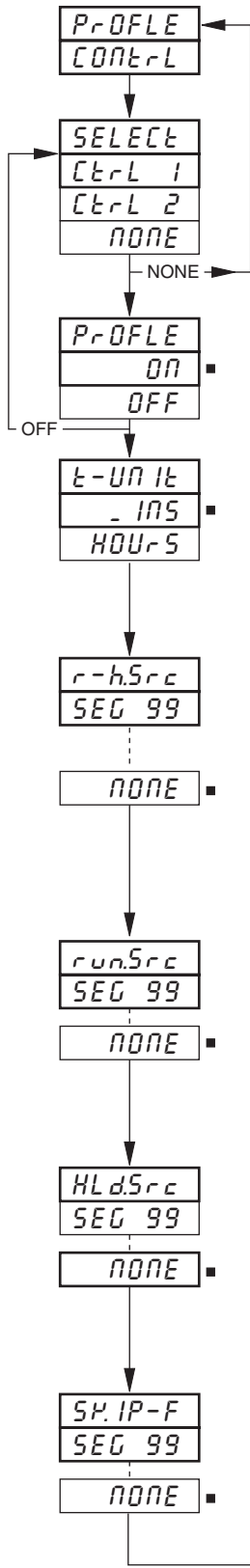

Page Header – Profile Control.

To advance to the Profile Program page press the switch.

Select Controller

Select the Controller to be programmed:

- CTRL 1 – Controller 1
- CTRL 2 – Controller 2 (if fitted)
- NONE – No controller selected

Ramp/Soak Profile Enable

If ON is selected, Profile Control is enabled and the Profile States Page is displayed in the OPERATOR LEVEL. If OFF is selected Profile Control is disabled and the Profile States Page is omitted from the OPERATOR LEVEL.

Program Time Units

Select the time units required:

- INS – Minutes
- HOURS – Hours

The time base selected applies to all segments.

Program Run/Hold Source

The run/hold source is level triggered i.e. the active logic state must be maintained to select the alternative function.

If a program is activated or placed into operator hold mode using Program Run/Hold Source, the Program Run Source and Program Hold Source have no effect.

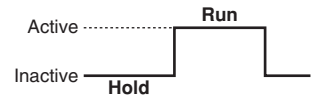

Select the source required to activate program run/hold – see Page 16, Table 4.1.

Program Run Source

The run source is leading edge triggered i.e. the active logic state can be removed after the function is selected.



Select the source required to run a program – see Page 16, Table 4.1.

Program Hold Source

The hold source is leading edge triggered.

Select the source required to place the program running into operator hold mode – see Page 16, Table 4.1.

The program is restarted using the Program Run Source.

Segment Skip Forward Source

If the segment running is the last segment of the program, the set point advances to the last set point value of the segment and stops the program. The skip source is leading edge triggered.

Select the source required to skip to the next segment – see Page 16, Table 4.1.

Continued on next page.

## ...4 CONTROL CONFIGURATION LEVEL

### ...4.5 Ramp/Soak Profile Control

SP.IP-b
SEG 99

NONE
------

rStSrc
SEG 99

NONE
------

IncSrc
SEG 99

NONE
------

dEcSrc
SEG 99

NONE
------

SP-Adj
100.0

OFF
-----

rESEt
ENbL-n
ENbL-y

SP.IP
ENbL-n
ENbL-y

SS SPt
OFF
ON

rEtOrt
OFF
A
b

#### Segment Skip Backward Source

The skip source is leading edge triggered.

Select the source required to skip back to the beginning of the ramp/soak segment running – see Page 16, Table 4.1.

#### Program Reset Source

The reset source is leading edge triggered.

If the program is running normally and is reset, the program returns to the beginning of the first segment and continues to run. If the program is on hold and is reset, the program returns to the beginning of the first segment and stops. No action is taken if a program has already finished.

Select the source required to reset a running program – see Page 16, Table 4.1.

#### Soak Time Increment Source (Current Segment)

The soak time of the current segment can be increased (by an amount set in the Soak Time Adjust frame) each time the source is activated. (ie. the source is leading edge triggered).

Select the source required to increase the soak time – see Page 16, Table 4.1.

#### Soak Time Decrement Source (Current Segment)

The soak time of the current segment can be decreased (by an amount set in the Soak Time Adjust frame) each time the source is activated. (ie. the source is leading edge triggered).

Select the source required to decrease the soak time – see Page 16, Table 4.1.

#### Soak Time Adjust (Current Segment)

The value set is added or subtracted from the soak time of a running segment via a digital signal or from the Controller 1 or 2 faceplates, when in the **Current Profile Segment** frame of the **Operating Page**.

The units of time are set in the **Time Units** frame. If *OFF* is selected this function is disabled.

Set the value required, between 0.1 and 100.0.

#### Reset Enable

Select *ENbL-y* to enable or *ENbL-n* to disable the **Profile Reset** frame in the **Profile States Page**, **OPERATOR LEVEL**.

#### Skip Enable

Select *ENbL-y* to enable or *ENbL-n* to disable the **Skip Segment** frames in the **Profile States Page**, **OPERATOR LEVEL**.

#### Self Seeking Set Point

If *ON* is selected the controller inserts the current process value as the starting point on initiation of the profile. This value is stored in the profile program and can be overwritten manually or when the program is next initiated. The ramp rate is unaffected. If *OFF* is selected the self seeking set point is disabled.

#### Retort

Select *A* to complete soak segment or *b* to repeat soak segment. If *OFF* is selected the retort mode is disabled.

Continued on next page.



...4.5 Ramp/Soak Profile Control

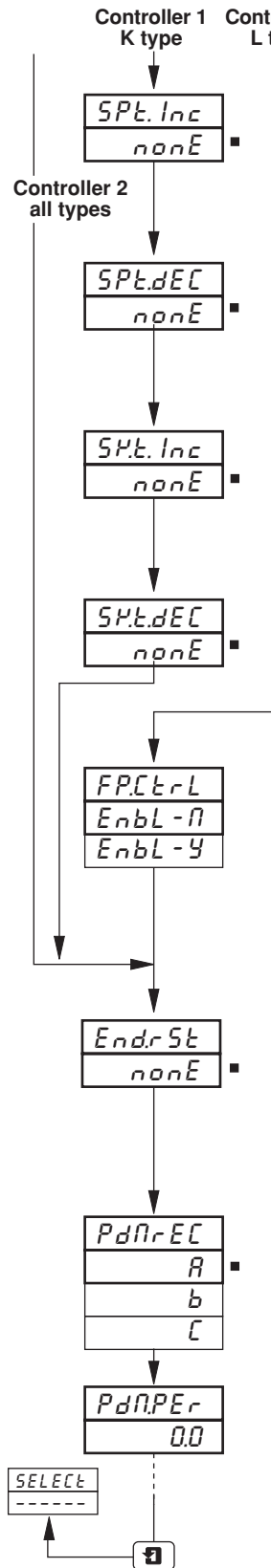

**Highest Soak Set Point Increment Source (K Type only)**

The set point value can be increased by activating a digital signal. The source is level triggered, therefore prolonged activation causes a larger change.

Select the source required to increase the set point value – see Page 16, Table 4.1.

**Highest Soak Set Point Decrement Source (K Type only)**

The set point value can be decreased by activating a digital signal. The source is level triggered, therefore prolonged activation causes a larger change.

Select the source required to decrease the set point value – see Page 16, Table 4.1.

**Soak Time Increment Source (K Type only)**

The Soak time can be increased by activating a digital signal. The source is level triggered, therefore prolonged activation causes a larger change.

Select the source required to increase the Soak time value – see Page 16, Table 4.1.

**Soak Time Decrement Source (K Type only)**

The Soak time can be decreased by activating a digital signal. The source is level triggered, therefore prolonged activation causes a larger change.

Select the source required to decrease the Soak time value – see Page 16, Table 4.1.

**Ramp/Soak Control Faceplate Enable (L Type only)**

The control keys on the Ramp/Soak Control Faceplate can be enabled/disabled.

Select *EnbL - Y* to allow the RUN, STOP and HOLD keys to be used.

**End of Profile Reset Source**

The end of profile state is an internal digital signal that is set automatically when the program is complete. The end of profile reset source is used to reset the end of profile state.

Select the source required to reset the end of profile state – see Page 16, Table 4.1. If 'NONE' is selected the end of profile state is reset after 2 seconds.

**Power-down Recovery Option**

Select the profile restart position when power is restored after a failure and the **Power Down Time Period** (see below) has expired: *A* – Start of the current program, controller set to *Hold* mode; *b* – start of the current segment, controller set to *Hold* mode; *C* – profile position unchanged, controller set to *Hold* mode.

**Power-down Time Period**

Set the time period (0.0 to 99.9 minutes) during which, if power is restored, the profile continues from the point at which power failed. If the **Power-down Time** is exceeded the **Power-down Recovery Option**, selected above, is invoked.

Return to **Select Controller** frame.

## ...4 CONTROL CONFIGURATION LEVEL

### ...4.5 Ramp/Soak Profile Program

Source	Description
* <i>PFAIL</i> <i>AL_RCP</i>	Power Failure An unacknowledged alarm anywhere in the unit
<i>TEU_1.1</i> ⋮ <i>TEU_1.6</i> <i>TEU_2.1</i> ⋮ <i>TEU_2.6</i> <i>SEG_99</i> ⋮ <i>SEG_0</i> <i>PG_2.10</i> ⋮ <i>PG_10.1</i> <i>END-x</i> <i>HbP-x</i> <i>HOLD-x</i> <i>rUN-x</i>	Time events channel 1  Time events channel 2  Profile segment 99  Profile segment 0 Profile program 10, Controller 2  Profile program 1, Controller 1 Program end – see Section 4.2.7 Program in hold due to holdback hysteresis Profile 1 or 2 in hold mode Profile 1 or 2 running
<i>OPEN-x</i> <i>CLSE-x</i>	Motorized valve 1 or 2 open Motorized valve 1 or 2 closed
<i>ONOFF-x</i> <i>OP-x</i> <i>OP-xc</i> <i>OP-xh</i>	Control output 1 or 2 on/off Control output 1 or 2 (time proportioning) Control output cool 1 or 2 (time proportioning) Control output heat 1 or 2 (time proportioning)
<i>2nd-x</i> <i>LOC-x</i>	Second set point Local set point
<i>_MAN-x</i> <i>AUTO-x</i>	Manual control Automatic control
<i>t1_Er.2</i> <i>t1_Er.1</i>	Real time event 2 Real time event 1
<i>EQN - 8</i> ⋮ <i>EQN - 1</i>	Logic equation 8  Logic equation 1
<i>dIG - 6.8</i> ⋮ <i>dIG - 1.1</i>	Digital Input 6.8  Digital input 1.1  Digital Input number Module number
<i>AL - d3</i> <i>AL - C3</i> <i>AL - b3</i> <i>AL - A3</i>	Alarm D Alarm C Alarm B Alarm A
<i>AL - d2</i> <i>AL - C2</i> <i>AL - b2</i> <i>AL - A2</i>	Alarm D Alarm C Alarm B Alarm A
<i>AL - d1</i> <i>AL - C1</i> <i>AL - b1</i> <i>AL - A1</i>	Alarm D Alarm C Alarm B Alarm A
<i>NONE</i>	No source required

\* Available only for relay assignment.

Table 4.1 Digital Sources

4.6 Ramp/Soak Profile Program

In this Section, parameters in the lower display denoted ■ are Company Standard Settings. The instrument is dispatched programmed with these settings.

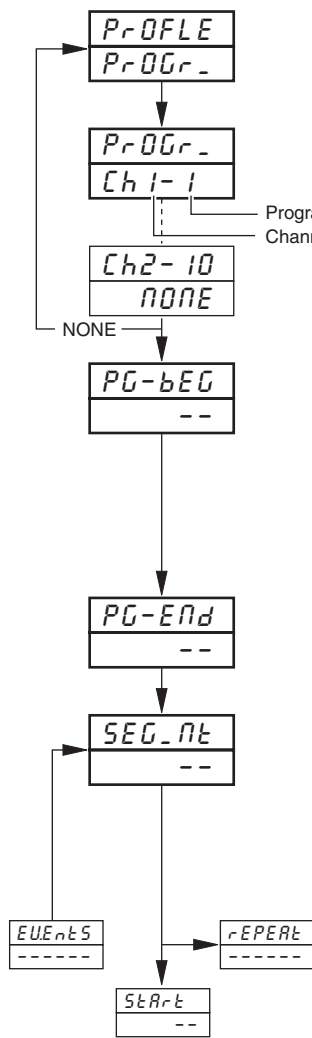

Page Header – **Profile Program.**

To return to the top of the **CONTROL CONFIGURATION LEVEL**, press the switch.

**Select Program**

Select the program to be configured:

- Program No. Ch 1- 1 to Ch 1- 10 – Channel 1 programs 1 to 10
- Channel No. Ch 2- 1 to Ch 2- 10 – Channel 2 programs 1 to 10 (if available)
- NONE – no program selected

**Program Begin**

Select the program start segment, between 1 and 99.

**Note.** Start a new program at least one segment after the end of the previous program, i.e. if program 1.1 uses segments 1 to 4, select segment 6 as the start segment for program 1.2. Segments can only be used in more than one program if the start, end, ramp and soak values are identical in each program that the segments are used.

**Program End**

Select the program end segment between, 1 and 99.

**Select Segment**

Select the segment to be programmed (1 to 99).

When all segments have been programmed, select 0 to advance to **Repeat Program** frame.

Continued on next page.

## ...4 CONTROL CONFIGURATION LEVEL

### ...4.6 Ramp/Soak Profile Program

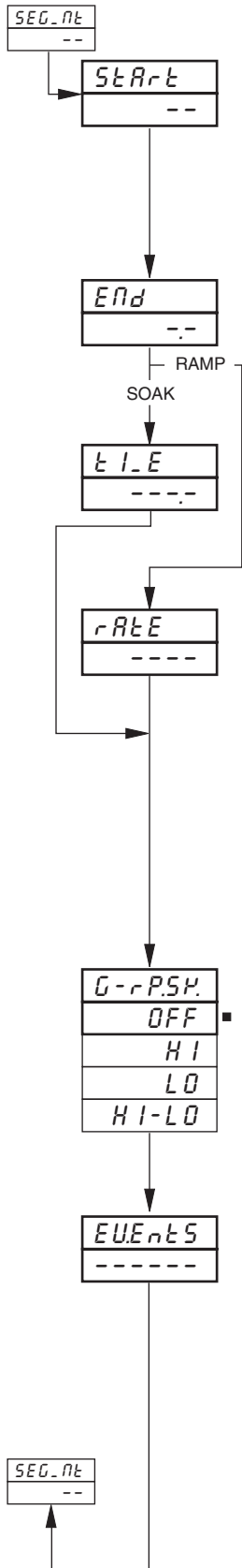

#### Segment Start Value

Set the segment start value. The segment start value can only be set if it is the first segment of a program.

A **Ramp** has different start and end set point values. A **Soak** has the same start and end set point values. Adjacent segments of different **Ramp** or **Soak** programs **MUST** have the same start and end values, unless an intermediate 'spacer' segment is used.

#### Segment End Value

Set the segment end value.

If segment start/end values are the same (Soak), the next frame displayed is the **Soak Time** frame. If they are different (Ramp), the next frame displayed is the **Ramp Rate** frame.

#### Soak Time

Set soak time duration required, between 0 and 999.9.

The time units (hours or minutes) are configured in **Ramp/Soak Time Units** frame, **Profile Control Page**.

#### Ramp Rate

Set the ramp rate.

The ramp rate is entered as the number of engineering units that change during the time period (hours or minutes) configured in the **Ramp/Soak Time Units** frame, **Profile Control Page**.

**Example** – If a ramp of 10°F at 2° every minute is required, the ramp rate value entered is 2.0 (in the minutes time base).

Ramp rates set excessively low over a wide range cannot be displayed properly at the **Current Profile Segment (Time Remaining)** frame. This display shows a maximum of 999.9 units of time. The display is decremental when the time remaining is less than 999.9.

#### Guaranteed Ramp/Soak Hysteresis

Select the hysteresis application required.

- OFF* – hysteresis not applied, ramp/soak not guaranteed.
- HI* – hysteresis applied above set point ( 'H-HOLD' set if PV > [SP + Hysteresis])
- LO* – hysteresis applied below set point ( 'H-HOLD' set if PV < [SP – Hysteresis])
- HI-LO* – hysteresis applied above and below set point ( 'H-HOLD' set if PV > [SP + Hysteresis] or PV < [SP – Hysteresis])

#### Time Events

Up to six Time-events can be assigned to the segment currently being programmed – see Fig. 4.8.

Press the  key to turn event 1 ON.

Press the  key to turn event 1 OFF.

Press the  key to advance to the next event.

**Example.** '1-34-5' indicates time events 1, 3, 4 and 6 active during this segment time events 2 and 5 inactive

Return to **Select Segment Frame**.

...4.6 Ramp/Soak Profile Program

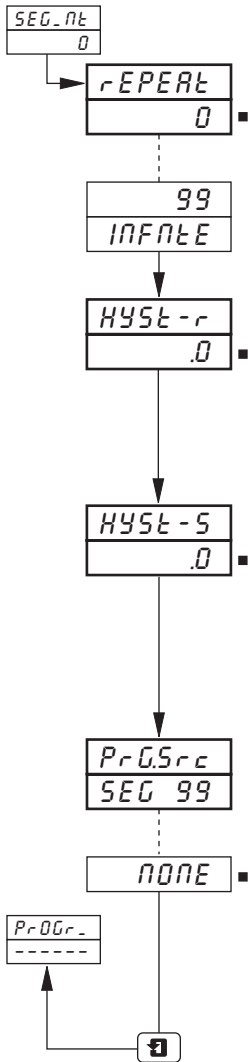

**Repeat Program Profile**

Set the number of times the program is to be repeated, between 0 and 99 or infinity.

If infinity is selected the program is repeated until stopped by the operator.

**Guaranteed Ramp Hysteresis**

The Guaranteed Ramp Hysteresis applies above the process variable, below or both depending on the application selected – see Hysteresis Application frame..

Set the value of the hysteresis band (in engineering units), between 0.001 and 9999.

Setting '0' is used if no deviation from the profile is allowed.

**Guaranteed Soak Hysteresis**

The Guaranteed Soak Hysteresis applies above the process variable, below or both depending on the application selected – see Hysteresis Application frame..

Set the value of the hysteresis band (in engineering units), between 0.001 and 9999.

Setting '0' is used if no deviation from the profile is allowed.

**Program Source**

The program source is leading edge triggered i.e. the active logic state can be removed after the function is selected.

Select the source required to select the program – see Section 4.5/ Table 4.1.

Return to **Select Program** frame.

# 5 ADVANCED CONFIGURATION LEVEL

## 5.1 Advanced Configuration Level – Fig. 5.1

The general content of the Advanced Configuration Level is detailed in *IMC1900-PGC, Section 5*. Any changed or additional frames are detailed in Sections 5.2.1 and 5.2.2 of this manual.

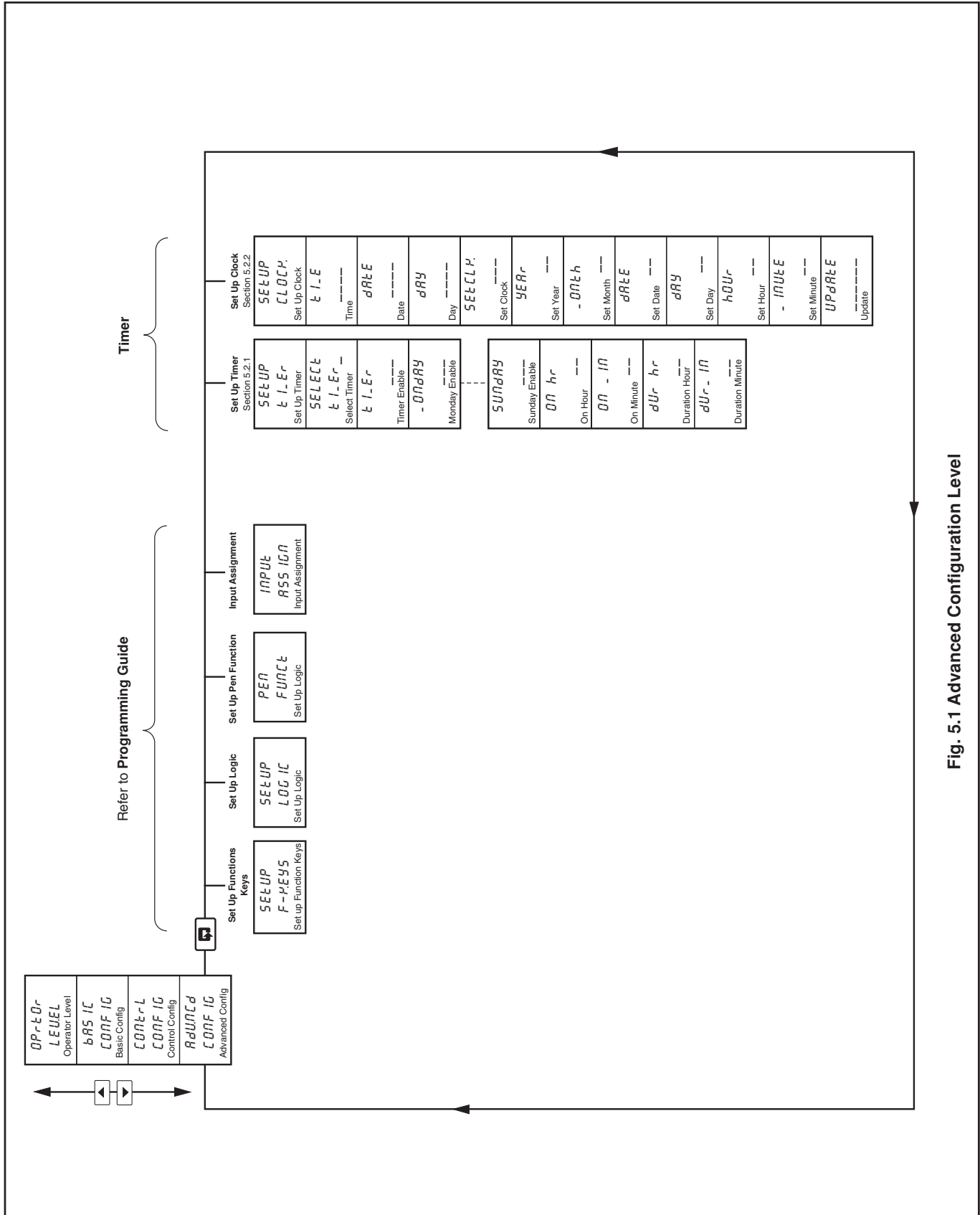

Fig. 5.1 Advanced Configuration Level

## ...5 ADVANCED CONFIGURATION LEVEL

### 5.2 Timer

#### 5.2.1 Set Up Timer

**Information.**

- **Two timers available.**
- **'ON' duration of 1 minute to 167 hours 59 minutes (1 week).**
- **Programmable Timers** – can operate on specific days, hours or minutes for an exact period of time.
- **Timer 'ON/OFF' states** – can be used to delay the start of ramp/soak profiles, energize relay outputs, acknowledge alarms, stop the chart, select auto/manual control modes and local/remote set points, in logic calculations, start/stop/reset totalizers, reset maths results or run/hold/reset profile programs/segments.

**Example A** – setting up timer:

- Monday enabled
- Tuesday disabled
- Wednesday disabled
- Thursday disabled
- Friday enabled
- Saturday disabled
- Sunday disabled
- on hour set to 10.00am
- on minute set to 30 minutes
- duration in hours set to 49 hours
- duration in minutes set to 30 minutes

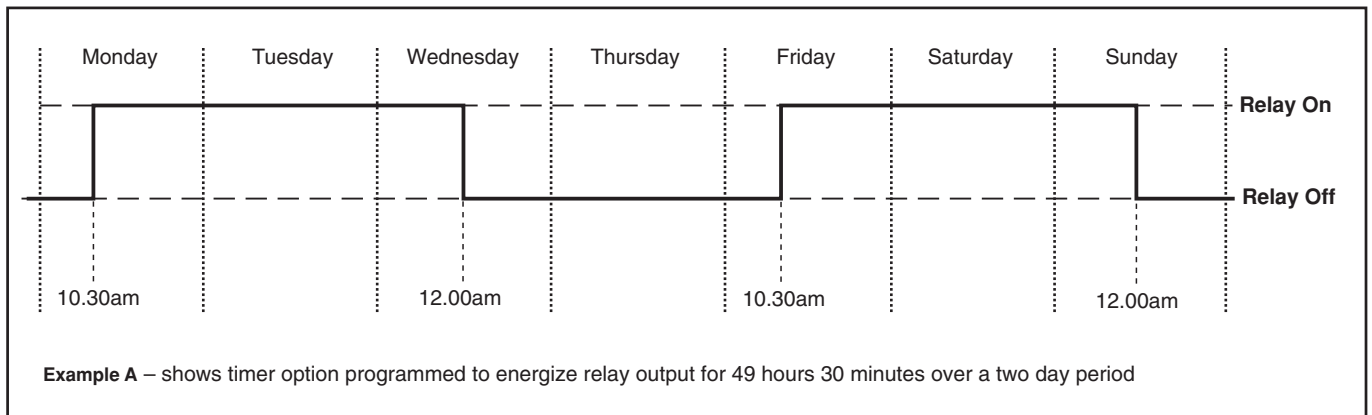

## ...5 ADVANCED CONFIGURATION LEVEL

### ...5.2.1 Set Up Timer

**Example B** – setting up timer:

- Monday enabled
- Tuesday enabled
- Wednesday enabled
- Thursday enabled
- Friday enabled
- Saturday disabled
- Sunday disabled
- on hour set to 06.00am
- on minute set to 0 minutes
- duration in hours set to 16 hours
- duration in minutes set to 10 minutes

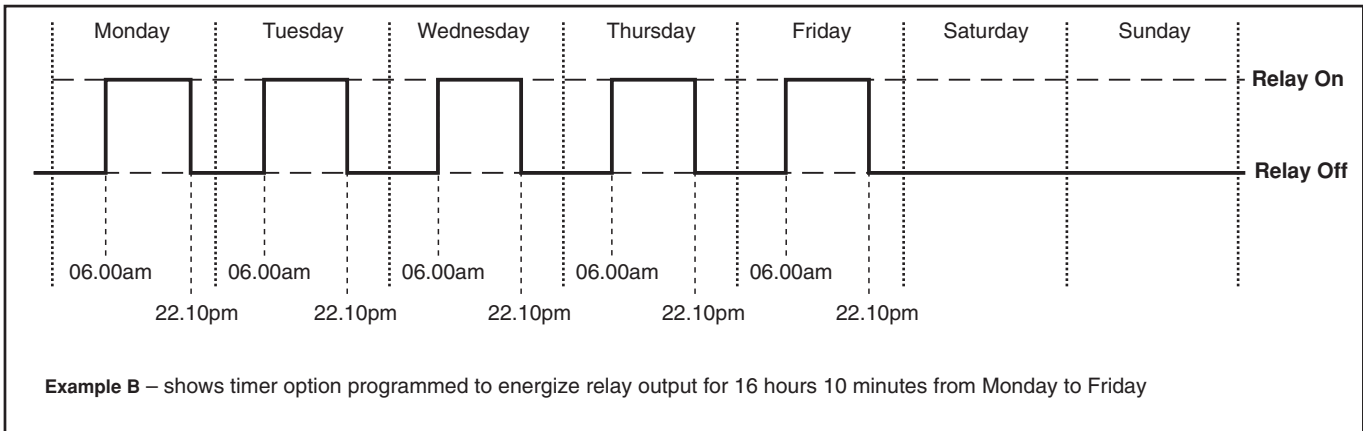

**Example C** – setting up timer:

- Monday enabled
- Tuesday disabled
- Wednesday disabled
- Thursday disabled
- Friday disabled
- Saturday disabled
- Sunday disabled
- on hour set to All
- on minute set to 20 minutes
- duration in hours set to 0 hours
- duration in minutes set to 40 minutes

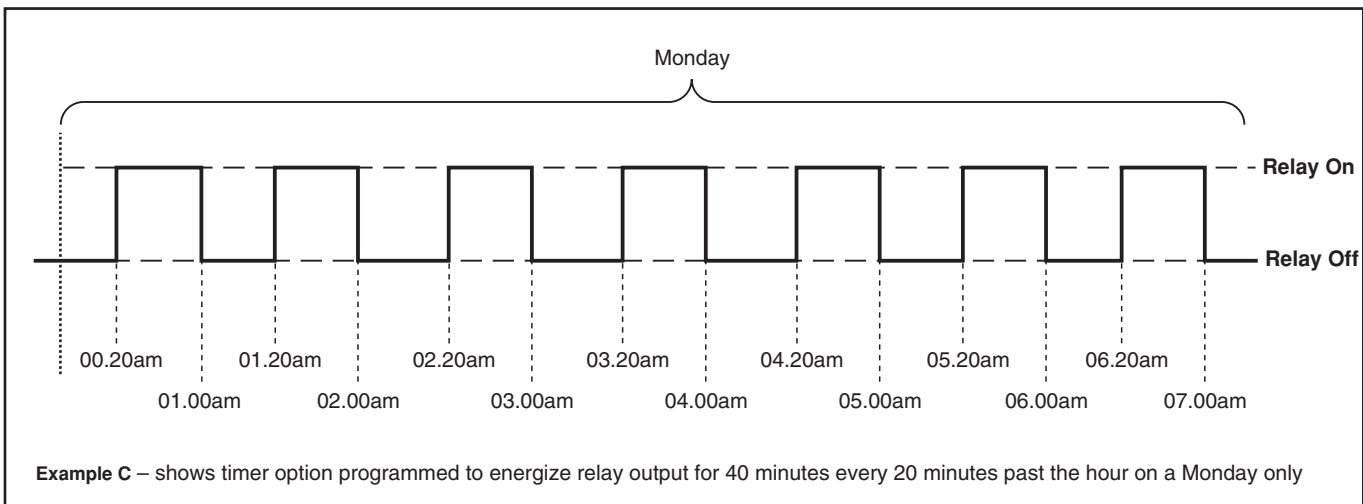



...5.2.1 Set Up Timer

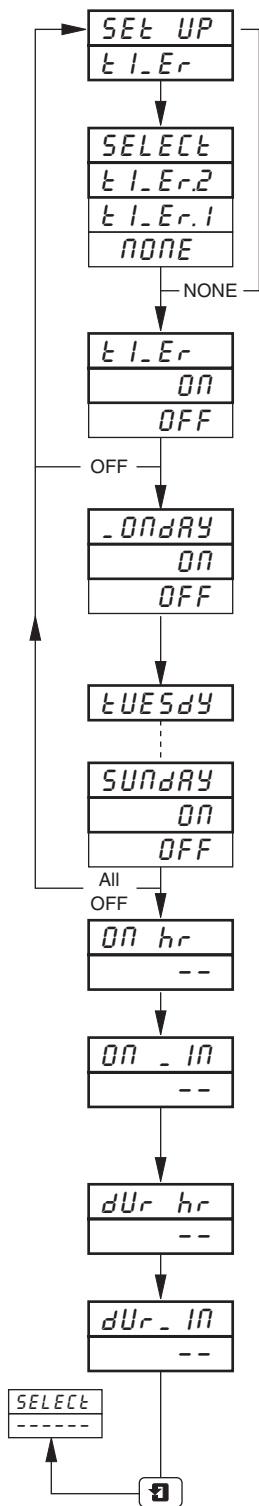

Page Header – Set Up Timer

To advance to the **Set Up Clock** frame press the switch.

**Select Timer**

Select timer to be programmed:

- t1\_Er.1 – Timer 1
- t1\_Er.2 – Timer 2
- none – no Timer selected

**Timer On/Off Enable**

Select *ON* to enable or *OFF* to disable.

**Monday Enable**

If Monday is enabled the timer becomes active on Monday. Select *ON* to enable or *OFF* to disable.

**Tuesday Enable**

Repeat as above for Tuesday to Sunday.

**On Hour**

Set the hour at which the timer becomes active. If *ALL* is selected the timer becomes active every hour (*ALL* is located above 24).

**On Minute**

Set the minute at which the timer becomes active.

**Duration Hour**

Set the duration of the timer in hours.

**Duration Minute**

Set the duration of the timer in minutes.

Return to **Select Timer** frame.

## ...5 ADVANCED CONFIGURATION LEVEL

### 5.2.2 Set Up Clock

#### Information.

- Real time system clock included with timer option.
- Provides date, month, day, hours, minutes.

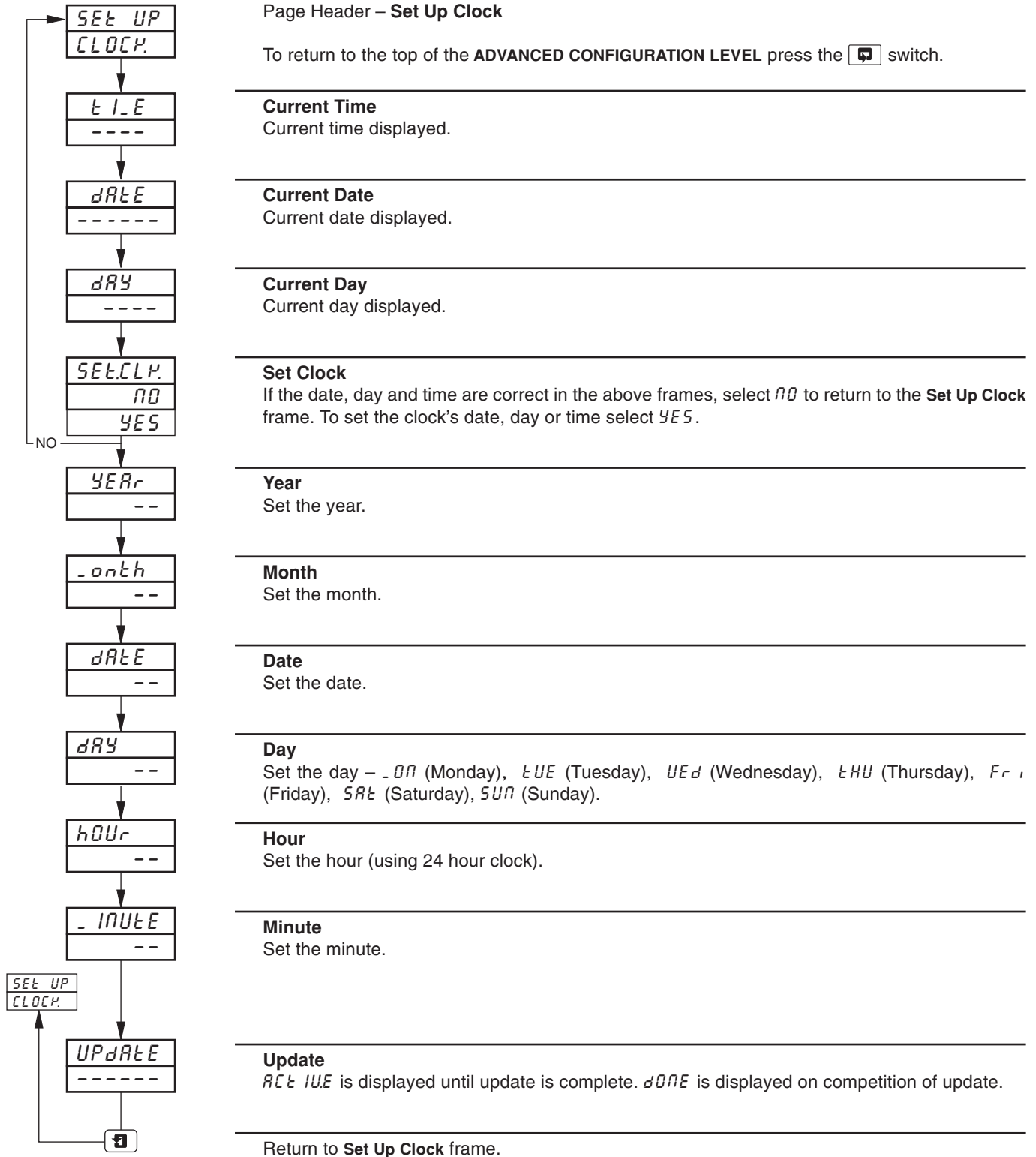

Sales



Service



Software



—

**ABB Limited**

**Measurement & Analytics**

Howard Road, St. Neots  
Cambridgeshire, PE19 8EU  
UK

Tel: +44 (0) 870 600 6122

Fax: +44 (0)1480 217 948

Email: [enquiries.mp.uk@gb.abb.com](mailto:enquiries.mp.uk@gb.abb.com)

**ABB Inc.**

**Measurement & Analytics**

125 E County Line Road  
Warminster, PA 18974  
USA

Tel: +1 215 674 6000

Fax: +1 215 674 7183

**[abb.com/measurement](http://abb.com/measurement)**



—

We reserve the right to make technical changes or modify the contents of this document without prior notice. With regard to purchase orders, the agreed particulars shall prevail. ABB does not accept any responsibility whatsoever for potential errors or possible lack of information in this document.

We reserve all rights in this document and in the subject matter and illustrations contained therein. Any reproduction, disclosure to third parties or utilization of its contents – in whole or in parts – is forbidden without prior written consent of ABB.