

Modular range Pilot devices

ABB

Modular range
22mm

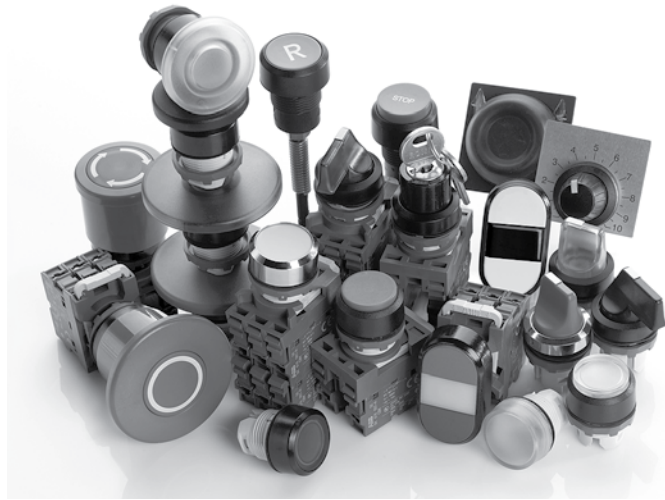

8

General construction

- Snap-on feature reduces installation time
- Bezels: Black plastic, chrome metal. Grey plastic available as an option
- Contact block holder features rear mounting with quick-release locking mechanism for high security
- Buttons available in several colors
- Engraved text caps available
- Custom-specific markings on request
- UL File# E76003
- CSA File# LR19700

Operators

- Pushbuttons, illuminated and non-illuminated
- Double pushbuttons, illuminated and non-illuminated
- Mushroom pushbuttons, illuminated and non-illuminated, Ø 40 mm and Ø 60 mm
- Emergency stop pushbuttons, illuminated and non-illuminated, twist or pull release
- Selector switches, illuminated and non-illuminated, 2 or 3 position, short or long handle
- Key operated selector switches, 2 or 3 position
- Toggle switches, 2 or 3 position

Pilot lights

- Full voltage, resistor and transformer
- LED & filament bulbs available for illuminated pushbuttons and pilot lights

Contact blocks

- Quick-mount, quick-release contact block holder for fast and easy assembly
- NO & NC contact blocks are color coded for easy identification: Green = NO, Red = NC
- Silver tipped contacts
- Wiping action for high reliability
- Low energy gold plated contact blocks
- Base mounted contact blocks which snap onto a 35 mm DIN rail or into a plastic enclosure
- Contact block holder for three or five blocks in a single row

Additional products

- Buzzer, continuous and pulsating
- 5 kΩ and 10 kΩ potentiometers
- Definite purpose pushbuttons
- Reset pushbuttons
- Broad range of accessories

General information Mounting

Exploded view

Contact block

Single pole with making or breaking contact

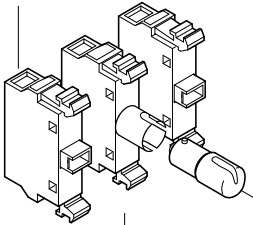

Holder

Available either for three or five blocks in one single row. Additional blocks can be stacked on holders for three blocks.

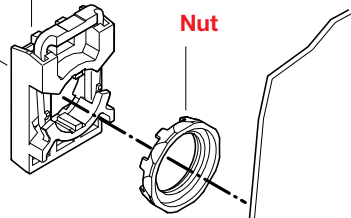

Nut

Legend plates

Of aluminum with slots that guide the legend plate and the operator into the correct position. Please, see the chapter 'legend plates' for more information.

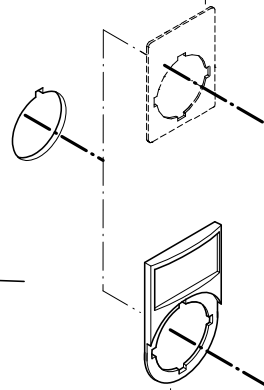

Lamp block

Illuminated pushbuttons, illuminated selector switches and pilot lights have a lamp block in the center position of the holder.

Operator

Buttons, lenses and handles in several colors. Illuminated or non-illuminated.

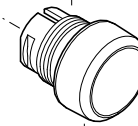

Legend plate holder

Of black plastic. Insert of brushed aluminum. Please, see the chapter 'legend plates' for more information.

Bezels

Pushbuttons, selector switches and toggle switches with bezel in black plastic, chrome metal are available.

8

Easy to mount

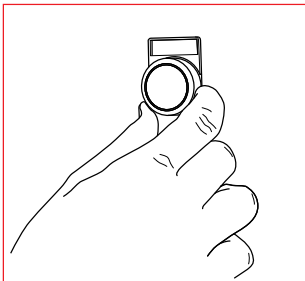

The operator is to be inserted from the front.....

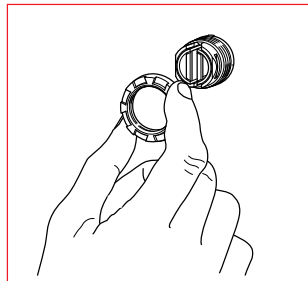

...and secured at the back with a nut.

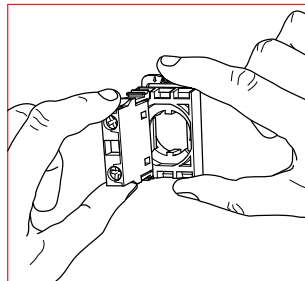

The contact blocks/lamp block are then snapped on to the holder...

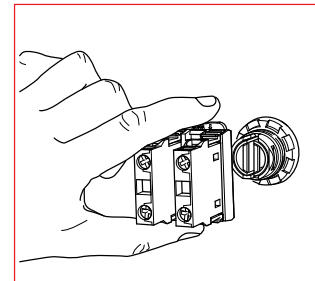

...and the holder snaps on to the operator.

...and to remove

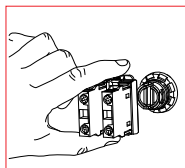
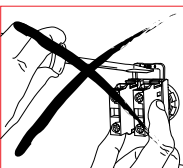

Press down the spring on the holder and pull the holder from the actuator.

Selection Guide

Pilot Devices
Modular Range
22mm

Pushbuttons and Mushroom pushbuttons

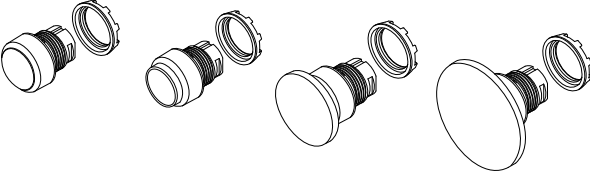

Contact block/lamp block combinations

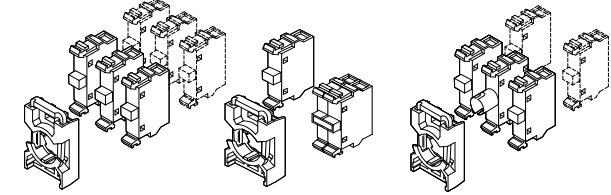

Double pushbuttons

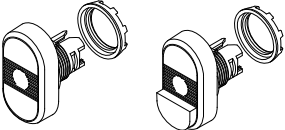

Contact block/lamp block combinations

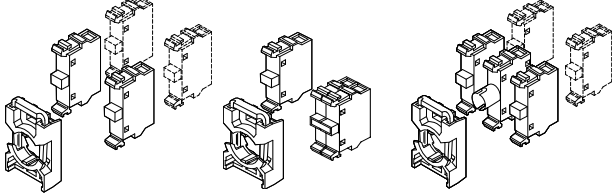

Emergency stop pushbuttons

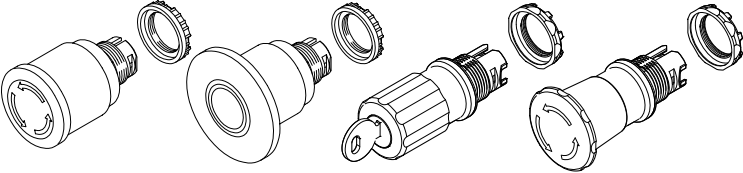

Contact block/lamp block combinations

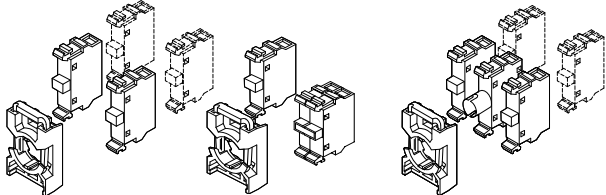

Selector switches

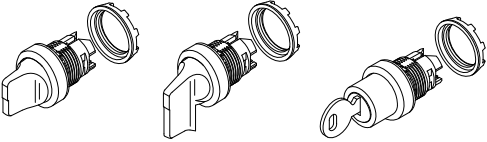

Contact block/lamp block combinations

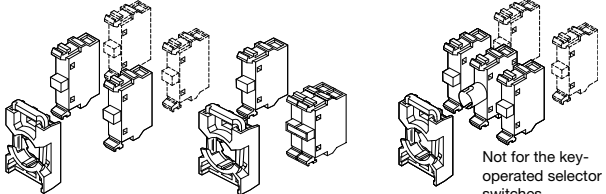

Not for the key-operated selector switches

Toggle switches

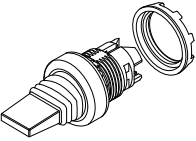

Contact block combinations

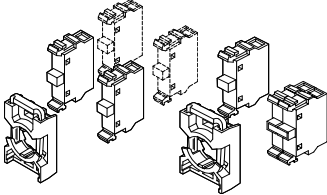

Definite purpose push-buttons

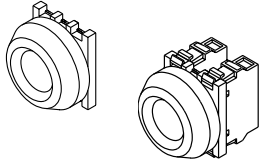

Reset pushbuttons

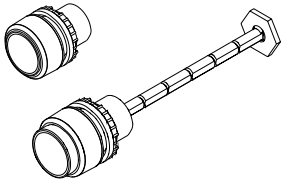

Pilot lights

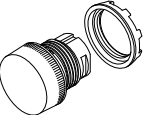

Lamp block combination

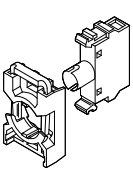

Buzzers

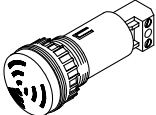

Potentiometers



8

Flush and extended pushbuttons

Non-illuminated

Momentary and maintained

Operator ...

Description	Catalog No.	Ref. Code	List Price
with flush button			
Momentary			
Red	MP1-10R	1SFA 611 100 R1001	\$ 6.10
Green	MP1-10G	1SFA 611 100 R1002	
Yellow	MP1-10Y	1SFA 611 100 R1003	
Blue	MP1-10L	1SFA 611 100 R1004	
White	MP1-10W	1SFA 611 100 R1005	
Black	MP1-10B	1SFA 611 100 R1006	
Clear	MP1-10C	1SFA 611 100 R1008	
Maintained			
Red	MP2-10R	1SFA 611 101 R1001	17.30
Green	MP2-10G	1SFA 611 101 R1002	
Yellow	MP2-10Y	1SFA 611 101 R1003	
Blue	MP2-10L	1SFA 611 101 R1004	
White	MP2-10W	1SFA 611 101 R1005	
Black	MP2-10B	1SFA 611 101 R1006	
Clear	MP2-10C	1SFA 611 101 R1008	

with extended button

Momentary			
Red	MP3-10R	1SFA 611 102 R1001	6.10
Green	MP3-10G	1SFA 611 102 R1002	
Yellow	MP3-10Y	1SFA 611 102 R1003	
Blue	MP3-10L	1SFA 611 102 R1004	
White	MP3-10W	1SFA 611 102 R1005	
Black	MP3-10B	1SFA 611 102 R1006	
Clear	MP3-10C	1SFA 611 102 R1008	
Maintained			
Red	MP4-10R	1SFA 611 103 R1001	17.30
Green	MP4-10G	1SFA 611 103 R1002	
Yellow	MP4-10Y	1SFA 611 103 R1003	
Blue	MP4-10L	1SFA 611 103 R1004	
White	MP4-10W	1SFA 611 103 R1005	
Black	MP4-10B	1SFA 611 103 R1006	
Clear	MP4-10C	1SFA 611 103 R1008	

Contact blocks, and holder

Blocks	Catalog No.	Ref. Code	List Price
1 NO with holder	MCBH-10	1SFA 611 605 R1101	\$ 10.00
1 NC with holder	MCBH-01	1SFA 611 605 R1110	10.00
2 NO with holder	MCBH-20	1SFA 611 605 R1102	18.00
2 NC with holder	MCBH-02	1SFA 611 605 R1120	18.00
1 NO + 1 NC with holder	MCBH-11	1SFA 611 605 R1111	18.00
1 NO without holder	MCB-10	1SFA 611 610 R1001	8.00
1 NC without holder	MCB-01	1SFA 611 610 R1010	8.00
Holder for 3 blocks	MCBH-00	1SFA 611 605 R1100	2.00

Ordering example

Requested: A modular pushbutton, momentary, with red flush button and one NO contact.

Ref.: 1 piece of MP1-10R + 1 piece of MCBH-10

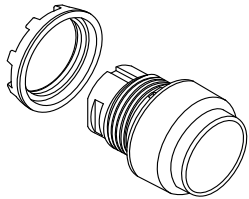
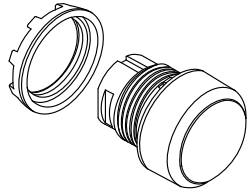
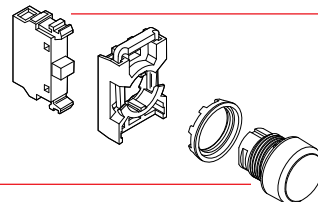

Bezel in black plastic as standard
Bezel in metal:
Replace '1' in the:
Cat No. MPX-1 0X
3 for metal bezel

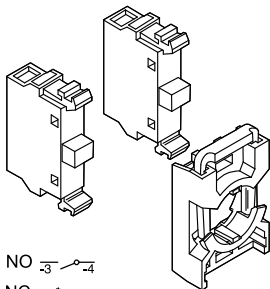

NO $\overline{3}$ - 4
NC $\overline{1}$ - 2

Flush and extended pushbuttons

Illuminated

Momentary and maintained

Bulb max 1.2 W

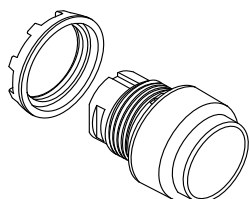
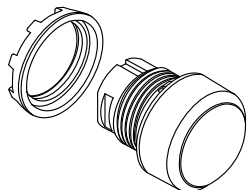

Bezel in black plastic as standard

Bezel in metal:

Replace '1' in the

Catalog No. MPX-1 0X

3 for metal bezel

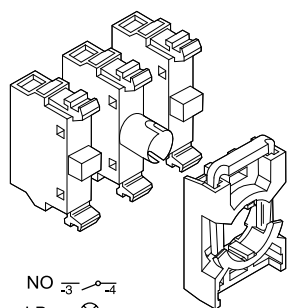

NO $\frac{3}{-}$ $\frac{4}{-}$
LB $\frac{x1}{\otimes}$ $\frac{x2}{\otimes}$
NC $\frac{1}{-}$ $\frac{2}{-}$

Operator ...

Description	Catalog No.	Ref. Code	List Price
with flush button			
Momentary ①			
Red	MP1-11R	1SFA 611 100 R1101	\$ 6.10
Green	MP1-11G	1SFA 611 100 R1102	
Yellow	MP1-11Y	1SFA 611 100 R1103	
Blue	MP1-11L	1SFA 611 100 R1104	
White	MP1-11W	1SFA 611 100 R1105	
Clear	MP1-11C	1SFA 611 100 R1108	
Maintained ①③			
Red	MP2-11R	1SFA 611 101 R1101	17.30
Green	MP2-11G	1SFA 611 101 R1102	
Yellow	MP2-11Y	1SFA 611 101 R1103	
Blue	MP2-11L	1SFA 611 101 R1104	
White	MP2-11W	1SFA 611 101 R1105	
Clear	MP2-11C	1SFA 611 101 R1108	
with extended button			
Momentary ①			
Red	MP3-11R	1SFA 611 102 R1101	6.10
Green	MP3-11G	1SFA 611 102 R1102	
Yellow	MP3-11Y	1SFA 611 102 R1103	
Blue	MP3-11L	1SFA 611 102 R1104	
White	MP3-11W	1SFA 611 102 R1105	
Clear	MP3-11C	1SFA 611 102 R1108	
Maintained ①③			
Red	MP4-11R	1SFA 611 103 R1101	17.30
Green	MP4-11G	1SFA 611 103 R1102	
Yellow	MP4-11Y	1SFA 611 103 R1103	
Blue	MP4-11L	1SFA 611 103 R1104	
White	MP4-11W	1SFA 611 103 R1105	
Clear	MP4-11C	1SFA 611 103 R1108	

Contact blocks, lamp block and holder ②

Blocks	Catalog No.	Ref. Code	List Price
1 NO + 1 LB with holder	MCBH-101	1SFA 611 605 R1201	\$ 27.50
1 NC + 1 LB with holder	MCBH-011	1SFA 611 605 R1210	27.50
2 NO + 1 LB with holder	MCBH-201	1SFA 611 605 R1202	35.50
2 NC + 1 LB with holder	MCBH-021	1SFA 611 605 R1220	35.50
1 NO + 1 NC + 1 LB with holder	MCBH-111	1SFA 611 605 R1211	35.50
1 NO without holder	MCB-10	1SFA 611 610 R1001	8.00
1 NC without holder	MCB-01	1SFA 611 610 R1010	8.00
Lamp block for 2 W, max 230 V AC/DC bulb or LED	MLB-1	1SFA 611 620 R1001	17.50
Holder for 3 blocks	MCBH-00	1SFA 611 605 R1100	2.00

Ordering example

Requested: A modular pushbutton, maintained and illuminated with green flush button and one NO + one NC contact.

Ref.: 1 piece of MP2-11G + 1 piece of MCBH-111
Bulb - see accessories

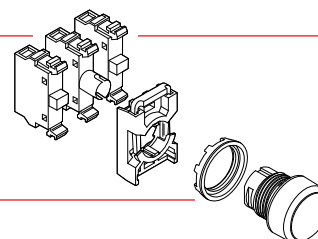

- ① No contact block in the center position, reserved for lamp block
- ② Lamp block MLB-1. Bulb not included. For other lamp blocks see Accessories.
- ③ Bulb max 1.2 W, not included.

Double pushbuttons Non-illuminated

Operator ...

Upper button		Lower button		Catalog No.	Ref. Code	List Price
Color	Text	Color	Text			
with flush buttons ①						
Green	No text	Red	No text	MPD1-11B	1SFA 611 130 R1106	\$ 18.00
	I	O	O	MPD2-11B	1SFA 611 131 R1106	21.00
	ON	OFF	OFF	MPD3-11B	1SFA 611 132 R1106	21.00
	START	STOP	STOP	MPD4-11B	1SFA 611 133 R1106	21.00
White	No text	Black	No text	MPD5-11B	1SFA 611 134 R1106	18.00
	I	O	O	MPD6-11B	1SFA 611 135 R1106	21.00
	ON	OFF	OFF	MPD7-11B	1SFA 611 136 R1106	21.00
	START	STOP	STOP	MPD8-11B	1SFA 611 137 R1106	21.00
with extended lower button ①						
Green	No text	Red	No text	MPD12-11B	1SFA 611 141 R1106	18.00
	I	O	O	MPD13-11B	1SFA 611 142 R1106	21.00
	ON	OFF	OFF	MPD14-11B	1SFA 611 143 R1106	21.00
	START	STOP	STOP	MPD15-11B	1SFA 611 144 R1106	21.00
White	No text	Black	No text	MPD16-11B	1SFA 611 145 R1106	18.00
	I	O	O	MPD17-11B	1SFA 611 146 R1106	21.00
	ON	OFF	OFF	MPD18-11B	1SFA 611 147 R1106	21.00
	START	STOP	STOP	MPD19-11B	1SFA 611 148 R1106	21.00

Contact blocks, and holder

Blocks	Catalog No.	Ref. Code	List Price
2 NO with holder	MCBH-20	1SFA 611 605 R1102	\$ 18.00
2 NC with holder	MCBH-02	1SFA 611 605 R1120	
1 NO + 1 NC with holder	MCBH-11	1SFA 611 605 R1111	
1 NO without holder	MCB-10	1SFA 611 610 R1001	8.00
1 NC without holder	MCB-01	1SFA 611 610 R1010	8.00
Holder for 3 blocks	MCBH-00	1SFA 611 605 R1100	2.00

Ordering example – Double pushbutton

Requested: A non-illuminated double pushbutton, Green/Red,
No text, with 2 NO blocks

Ref.: 1 piece of MPD1-11B + 1 piece of MCBH-20

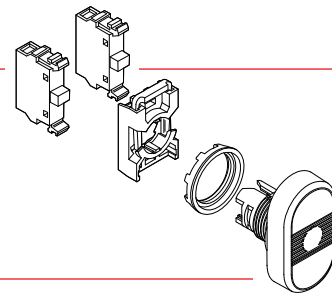

① No contact block in the center position.

Double pushbuttons Illuminated

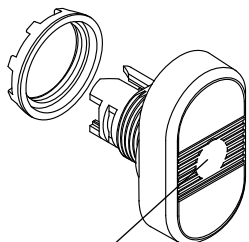

Lens colors:
Red
Green
Yellow
Clear

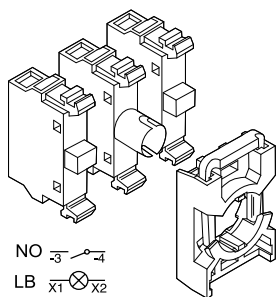

Operator ...

Upper button		Lower button		Catalog No.	Ref. Code	List Price
Color	Text	Color	Text			
with flush buttons ①						
Red lens						
Green	No text	Red	No text	MPD1-11R	1SFA 611 130 R1101	\$ 26.00
	I		O	MPD2-11R	1SFA 611 131 R1101	29.00
	ON		OFF	MPD3-11R	1SFA 611 132 R1101	29.00
	START		STOP	MPD4-11R	1SFA 611 133 R1101	29.00
White	No text	Black	No text	MPD5-11R	1SFA 611 134 R1101	26.00
	I		O	MPD6-11R	1SFA 611 135 R1101	29.00
	ON		OFF	MPD7-11R	1SFA 611 136 R1101	29.00
	START		STOP	MPD8-11R	1SFA 611 137 R1101	29.00
Green lens						
Green	No text	Red	No text	MPD1-11G	1SFA 611 130 R1102	26.00
	I		O	MPD2-11G	1SFA 611 131 R1102	29.00
	ON		OFF	MPD3-11G	1SFA 611 132 R1102	29.00
	START		STOP	MPD4-11G	1SFA 611 133 R1102	29.00
White	No text	Black	No text	MPD5-11G	1SFA 611 134 R1102	26.00
	I		O	MPD6-11G	1SFA 611 135 R1102	29.00
	ON		OFF	MPD7-11G	1SFA 611 136 R1102	29.00
	START		STOP	MPD8-11G	1SFA 611 137 R1102	29.00
Yellow lens						
Green	No text	Red	No text	MPD1-11Y	1SFA 611 130 R1103	26.00
	I		O	MPD2-11Y	1SFA 611 131 R1103	29.00
	ON		OFF	MPD3-11Y	1SFA 611 132 R1103	29.00
	START		STOP	MPD4-11Y	1SFA 611 133 R1103	29.00
White	No text	Black	No text	MPD5-11Y	1SFA 611 134 R1103	26.00
	I		O	MPD6-11Y	1SFA 611 135 R1103	29.00
	ON		OFF	MPD7-11Y	1SFA 611 136 R1103	29.00
	START		STOP	MPD8-11Y	1SFA 611 137 R1103	29.00
Clear lens						
Green	No text	Red	No text	MPD1-11C	1SFA 611 130 R1108	26.00
	I		O	MPD2-11C	1SFA 611 131 R1108	29.00
	ON		OFF	MPD3-11C	1SFA 611 132 R1108	29.00
	START		STOP	MPD4-11C	1SFA 611 133 R1108	29.00
White	No text	Black	No text	MPD5-11C	1SFA 611 134 R1108	26.00
	I		O	MPD6-11C	1SFA 611 135 R1108	29.00
	ON		OFF	MPD7-11C	1SFA 611 136 R1108	29.00
	START		STOP	MPD8-11C	1SFA 611 137 R1108	29.00

Contact blocks, lamp block and holder ②

Blocks	Catalog No.	Ref. Code	List Price
2 NO + 1 LB with holder	MCBH-201	1SFA 611 605 R1202	\$ 35.50
2 NC + 1 LB with holder	MCBH-021	1SFA 611 605 R1220	
1 NO + 1 NC + 1 LB with holder	MCBH-111	1SFA 611 605 R1211	
1 NO without holder	MCB-10	1SFA 611 610 R1001	8.00
1 NC without holder	MCB-01	1SFA 611 610 R1010	8.00
Lamp block for 2 W, max 230 V AC/DC bulb or LED	MLB-1	1SFA 611 620 R1001	17.50
Holder for 3 blocks	MCBH-00	1SFA 611 605 R1100	2.00

① No contact block in the center position, reserved for lamp block.

② Lamp block MLB-1. Bulb not included. For other lamp blocks see Accessories, bulb max 1.2 W.

Double pushbuttons Illuminated

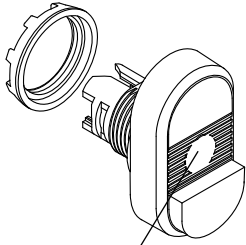

Lens colors:
Red
Green
Yellow
Clear

Operator ...

Upper button		Lower button		Catalog No.	Ref. Code	List Price
Color	Text	Color	Text			

with extended lower button ①

Red lens

Green	No text	Red	No text	MPD12-11R	1SFA 611 141 R1101	\$ 26.00			
			O				MPD13-11R	1SFA 611 142 R1101	29.00
	ON		OFF				MPD14-11R	1SFA 611 143 R1101	29.00
	START		STOP				MPD15-11R	1SFA 611 144 R1101	29.00
White	No text	Black	No text	MPD16-11R	1SFA 611 145 R1101	26.00			
			O				MPD17-11R	1SFA 611 146 R1101	29.00
	ON		OFF				MPD18-11R	1SFA 611 147 R1101	29.00
	START		STOP				MPD19-11R	1SFA 611 148 R1101	29.00

Green lens

Green	No text	Red	No text	MPD12-11G	1SFA 611 141 R1102	26.00			
			O				MPD13-11G	1SFA 611 142 R1102	29.00
	ON		OFF				MPD14-11G	1SFA 611 143 R1102	29.00
	START		STOP				MPD15-11G	1SFA 611 144 R1102	29.00
White	No text	Black	No text	MPD16-11G	1SFA 611 145 R1102	26.00			
			O				MPD17-11G	1SFA 611 146 R1102	29.00
	ON		OFF				MPD18-11G	1SFA 611 147 R1102	29.00
	START		STOP				MPD19-11G	1SFA 611 148 R1102	29.00

Yellow lens

Green	No text	Red	No text	MPD12-11Y	1SFA 611 141 R1103	26.00			
			O				MPD13-11Y	1SFA 611 142 R1103	29.00
	ON		OFF				MPD14-11Y	1SFA 611 143 R1103	29.00
	START		STOP				MPD15-11Y	1SFA 611 144 R1103	29.00
White	No text	Black	No text	MPD16-11Y	1SFA 611 145 R1103	26.00			
			O				MPD17-11Y	1SFA 611 146 R1103	29.00
	ON		OFF				MPD18-11Y	1SFA 611 147 R1103	29.00
	START		STOP				MPD19-11Y	1SFA 611 148 R1103	29.00

Clear lens

Green	No text	Red	No text	MPD12-11C	1SFA 611 141 R1108	26.00			
			O				MPD13-11C	1SFA 611 142 R1108	29.00
	ON		OFF				MPD14-11C	1SFA 611 143 R1108	29.00
	START		STOP				MPD15-11C	1SFA 611 144 R1108	29.00
White	No text	Black	No text	MPD16-11C	1SFA 611 145 R1108	26.00			
			O				MPD17-11C	1SFA 611 146 R1108	29.00
	ON		OFF				MPD18-11C	1SFA 611 147 R1108	29.00
	START		STOP				MPD19-11C	1SFA 611 148 R1108	29.00

Contact blocks, lamp block and holder ②

Blocks	Catalog No.	Ref. Code	List Price
2 NO + 1 LB with holder	MCBH-201	1SFA 611 605 R1202	\$ 35.50
2 NC + 1 LB with holder	MCBH-021	1SFA 611 605 R1220	35.50
1 NO + 1 NC + 1 LB with holder	MCBH-111	1SFA 611 605 R1211	35.50
1 NO without holder	MCB-10	1SFA 611 610 R1001	8.00
1 NC without holder	MCB-01	1SFA 611 610 R1010	8.00
Lamp block for 2 W, max 230 V AC/DC bulb or LED	MLB-1	1SFA 611 620 R1001	17.50
Holder for 3 blocks	MCBH-00	1SFA 611 605 R1100	2.00

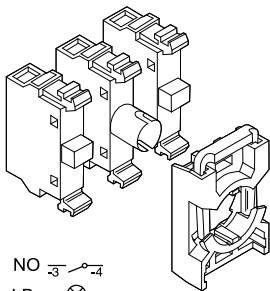

NO $\begin{matrix} \text{---} \\ \text{---} \end{matrix}$
LB $\begin{matrix} \text{---} \\ \text{---} \end{matrix}$
NC $\begin{matrix} \text{---} \\ \text{---} \end{matrix}$

① No contact block in the center position, reserved for lamp block.

② Lamp block MLB-1. Bulb not included. Other lamp block see Accessories, bulb max 1.2 W.

Mushroom pushbuttons

Non-illuminated and illuminated

Momentary

Operator ...

Operator material	Button color	Catalog No.	Ref. Code	List Price
non-illuminated				
Ø 40 mm				
Plastic	Red	MPM1-10R	1SFA 611 124 R1001	\$ 16.00
	Yellow	MPM1-10Y	1SFA 611 124 R1003	16.00
	Black	MPM1-10B	1SFA 611 124 R1006	16.00
Ø 60 mm				
Plastic	Red	MPM2-10R	1SFA 611 125 R1001	20.00
	Yellow	MPM2-10Y	1SFA 611 125 R1003	20.00
	Black	MPM2-10B	1SFA 611 125 R1006	20.00
illuminated ①				
Ø 40 mm				
Plastic	Green	MPM1-11G	1SFA 611 124 R1102	16.00
	Red	MPM1-11R	1SFA 611 124 R1101	15.50
	Yellow	MPM1-11Y	1SFA 611 124 R1103	15.50
Ø 60 mm				
Plastic	Red	MPM2-11R	1SFA 611 125 R1101	20.00
	Yellow	MPM2-11Y	1SFA 611 125 R1103	20.00

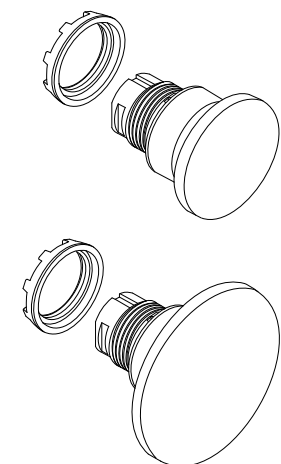

Bezel in black plastic as standard
Bezel in metal:
Replace '1' in the:
Catalog No. MPMX-1 0X
Ref. Code 1SFA611XXX R 1XXX
3 for metal bezel

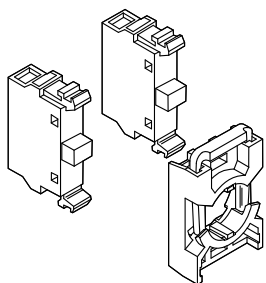

Contact blocks, lamp block and holder ②

Blocks	Catalog No.	Ref. Code	List Price
1 NO with holder	MCBH-10	1SFA 611 605 R1101	\$ 10.00
1 NC with holder	MCBH-01	1SFA 611 605 R1110	10.00
2 NO with holder	MCBH-20	1SFA 611 605 R1102	18.00
2 NC with holder	MCBH-02	1SFA 611 605 R1120	18.00
1 NO + 1 NC with holder	MCBH-11	1SFA 611 605 R1111	18.00
1 NO + 1 LB with holder	MCBH-101	1SFA 611 605 R1201	27.50
1 NC + 1 LB with holder	MCBH-011	1SFA 611 605 R1210	27.50
2 NO + 1 LB with holder	MCBH-201	1SFA 611 605 R1202	35.50
2 NC + 1 LB with holder	MCBH-021	1SFA 611 605 R1220	35.50
1 NO + 1 NC + 1 LB with holder	MCBH-111	1SFA 611 605 R1211	35.50
1 NO without holder	MCB-10	1SFA 611 610 R1001	8.00
1 NC without holder	MCB-01	1SFA 611 610 R1010	8.00
Lamp block for 2 W, max 230 V AC/DC bulb or LED	MLB-1	1SFA 611 620 R1001	17.50
Holder for 3 blocks	MCBH-00	1SFA 611 605 R1100	2.00

Ordering example – Mushroom Pushbutton

Requested: A modular mushroom pushbutton, Ø 40 mm, illuminated, red, with one NO + one NC contact and a standard lamp block

Ref.: 1 piece of MPM1-11R + 1 piece of MCBH-111
Bulb - see accessories

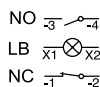
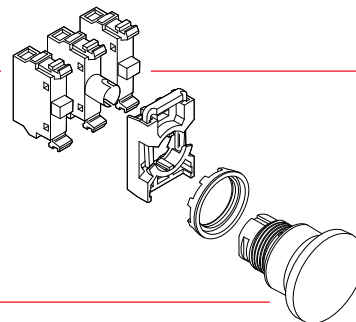

① No contact block in the center position, reserved for lamp block.
② Lamp block MLB-1. Bulb not included. Other lamp block see Accessories, bulb max 1.2 W.

Emergency stop pushbuttons

Non-illuminated, 30mm & 40mm head

Fulfills IEC 60947-5-5

Operator

Operator function	Button color and material	Catalog No.	Ref. Code	List Price
Non-illuminated ø 30mm				
Twist release	Red, plastic	MPET3-10R	1SFA611520R1001	\$ 26.00
Pull release	Red, plastic	MPEP3-10R	1SFA611521R1001	26.00
Key release				
(Key code 71, Ronis 455)	Red, plastic	MPEK3-11R	1SFA611522R1101	40.00
(Key code 72, Ronis 421)	Red, plastic	MPEK3-12R	1SFA611522R1201	40.00
(Key code 73, Ronis 3433-E)	Red, plastic	MPEK3-13R	1SFA611522R1301	40.00
Non-illuminated ø 40mm				
Twist release	Red, plastic	MPET4-10R	1SFA611523R1001	30.00
Pull release	Red, plastic	MPEP4-10R	1SFA611524R1001	30.00
Key release				
(Key code 71, Ronis 455)	Red, plastic	MPEK4-11R	1SFA611525R1101	48.00
(Key code 72, Ronis 421)	Red, plastic	MPEK4-12R	1SFA611525R1201	48.00
(Key code 73, Ronis 3433-E)	Red, plastic	MPEK4-13R	1SFA611525R1301	48.00

Contact blocks and holder

Blocks	Catalog No.	Ref. Code	List Price
1 NO with holder	MCBH-10	1SFA 611 605 R1101	\$ 10.00
1 NC with holder	MCBH-01	1SFA 611 605 R1110	10.00
2 NO with holder	MCBH-20	1SFA 611 605 R1102	18.00
2 NC with holder	MCBH-02	1SFA 611 605 R1120	18.00
1 NO + 1 NC with holder	MCBH-11	1SFA 611 605 R1111	18.00
1 NO without holder	MCB-10	1SFA 611 610 R1001	8.00
1 NC without holder	MCB-01	1SFA 611 610 R1010	8.00

To comply with the standard, IEC 60947-5-5, a number of tests have to be conducted:

Durability test	6,050 cycles. This is not a test of mechanical life. The product has a mechanical life of 100,000 operations.	Latching test	Impulse voltage test at 2,500 V
Robustness	The force 113 N applied in three axes	Resetting test	Pulling force < 50 N Turning torque < 1 Nm
Conditioning	Heat and cold, moist atmosphere, and in 5 % NaCl	Shock	15 g shock
		Vibration	2 h at 50m/s ²
		Contacts with positive opening operation	15 g shock

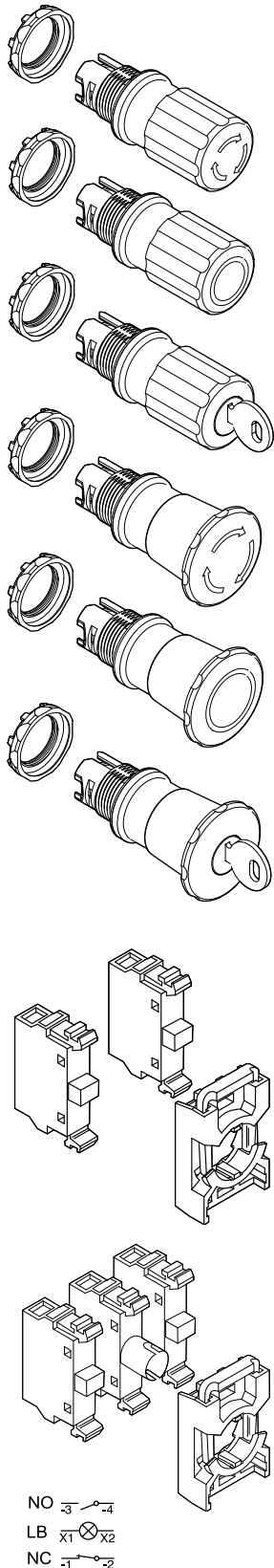

Emergency stop pushbuttons

Non-illuminated and illuminated, 40mm & 60mm head

Fulfills IEC 60947-5-5

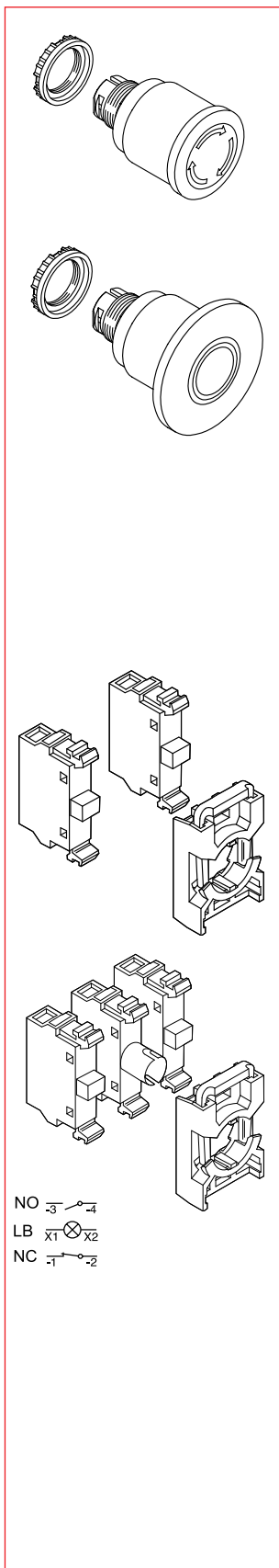

Operator ...

Operator function	Button color and material	Catalog No.	Ref. Code	List Price
Non-illuminated				
Ø 40 mm				
Twist release	Red, plastic	MPMT3-10R	1SFA 611 510 R1001	\$ 34.00
Pull release	Red, plastic	MPMP3-10R	1SFA 611 511 R1001	
Twist release	Black, plastic	MPMT3-10B	1SFA 611 510 R1006	
Pull release	Black, plastic	MPMP3-10B	1SFA 611 511 R1006	
Ø 60 mm				
Twist release	Red, plastic	MPMT4-10R	1SFA 611 510 R1006	46.00
Pull release	Red, plastic	MPMP4-10R	1SFA 611 511 R1006	
illuminated ①				
Ø 40 mm				
Twist release	Red, plastic	MPMT3-11R	1SFA 611 510 R1101	34.00
Pull release	Red, plastic	MPMP3-11R	1SFA 611 511 R1101	
Ø 60 mm				
Twist release	Red, plastic	MPMT4-11R	1SFA 611 513 R1101	46.00
Pull release	Red, plastic	MPMP4-11R	1SFA 611 514 R1101	

For compact E-Stops, see page 8.31.

Contact blocks, lamp block and holder ②

Blocks	Catalog No.	Ref. Code	List Price
1 NO with holder	MCBH-10	1SFA 611 605 R1101	\$ 10.00
1 NC with holder	MCBH-01	1SFA 611 605 R1110	10.00
2 NO with holder	MCBH-20	1SFA 611 605 R1102	18.00
2 NC with holder	MCBH-02	1SFA 611 605 R1120	18.00
1 NO + 1 NC with holder	MCBH-11	1SFA 611 605 R1111	18.00
1 NO + 1 LB with holder	MCBH-101	1SFA 611 605 R1201	27.50
1 NC + 1 LB with holder	MCBH-011	1SFA 611 605 R1210	27.50
2 NO + 1 LB with holder	MCBH-201	1SFA 611 605 R1202	35.50
2 NC + 1 LB with holder	MCBH-021	1SFA 611 605 R1220	35.50
1 NO + 1 NC + 1 LB with holder	MCBH-111	1SFA 611 605 R1211	35.50
1 NO without holder	MCB-10	1SFA 611 610 R1001	8.00
1 NC without holder	MCB-01	1SFA 611 610 R1010	8.00
Lamp block for 2 W, max 230 V AC/DC bulb or LED	MLB-1	1SFA 611 620 R1001	17.50
Holder for 3 blocks	MCBH-00	1SFA 611 605 R1100	2.00

To comply with the standard, IEC 60947-5-5, a number of tests have to be conducted:

Durability test	6,050 cycles. This is not a test of mechanical life. The product has a mechanical life of 100,000 operations.	Latching test	Impulse voltage test at 2,500 V
Robustness	The force 113 N applied in three axes	Resetting test	Pulling force < 50 N Turning torque < 1 Nm
Conditioning	Heat and cold, moist atmosphere, and in 5 % NaCl	Shock	15 g shock
		Vibration	2 h at 50m/s ²
		Contacts with positive opening operation	15 g shock

① No contact in the center position

② Lamp block MLB-1. Bulb not included. Other lamp block see Accessories, bulb max 2 W.

2-position selector switches Non-illuminated

Operator ...

Symbol	Handle color	Catalog No.	Ref. Code	List Price
with short handle ①				
Maintained				
	Red	M2SS1-10R	1SFA 611 200 R1001	\$ 11.00
	Black	M2SS1-10B	1SFA 611 200 R1006	
	Grey	M2SS1-10U	1SFA 611 200 R1007	
Maintained				
	Red	M2SS2-10R	1SFA 611 201 R1001	\$ 11.00
	Black	M2SS2-10B	1SFA 611 201 R1006	
	Grey	M2SS2-10U	1SFA 611 201 R1007	
Momentary, spring return from C to B				
	Red	M2SS3-10R	1SFA 611 202 R1001	14.00
	Black	M2SS3-10B	1SFA 611 202 R1006	
	Grey	M2SS3-10U	1SFA 611 202 R1007	
with long handle ①				
Maintained				
	Red	M2SS4-10R	1SFA 611 203 R1001	11.00
	Black	M2SS4-10B	1SFA 611 203 R1006	
	Grey	M2SS4-10U	1SFA 611 203 R1007	
Maintained				
	Red	M2SS5-10R	1SFA 611 204 R1001	11.00
	Black	M2SS5-10B	1SFA 611 204 R1006	
	Grey	M2SS5-10U	1SFA 611 200 R1007	
Momentary, spring return from C to B				
	Red	M2SS6-10R	1SFA 611 205 R1001	14.00
	Black	M2SS6-10B	1SFA 611 205 R1006	
	Grey	M2SS6-10U	1SFA 611 205 R1007	

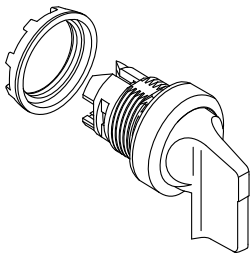
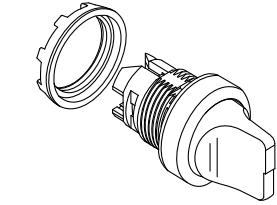

Bezel in black plastic as standard
Bezel in metal:
Replace '1' in the:
Catalog No. M2SSX-1 0X
Ref. Code 1SFA61 XXX R 1XXX
3 for metal bezel

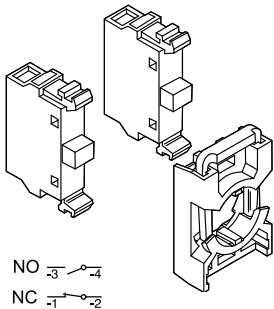

Contact functions

Block positions as seen from operator front.

Handle position	Left block	Right block
A (B)	O	O
C	x	x

O = not actuated (normal state)
x = actuated (state changed)

Contact blocks and holder

Blocks	Catalog No.	Ref. Code	List Price
1 NO with holder	MCBH-10	1SFA 611 605 R1101	\$ 10.00
1 NC with holder	MCBH-01	1SFA 611 605 R1110	10.00
2 NO with holder	MCBH-20	1SFA 611 605 R1102	18.00
2 NC with holder	MCBH-02	1SFA 611 605 R1120	18.00
1 NO + 1 NC with holder	MCBH-11	1SFA 611 605 R1111	18.00
1 NO without holder	MCB-10	1SFA 611 610 R1001	8.00
1 NC without holder	MCB-01	1SFA 611 610 R1010	8.00
Holder for 3 blocks	MCBH-00	1SFA 611 605 R1100	2.00

Ordering example

Requested: A non-illuminated modular selector switch. Black.
Maintained.
Handle positions: A and C
With 2 NC contacts

Ref.: 1 piece of M2SS2-10B + 1 piece of MCBH-02

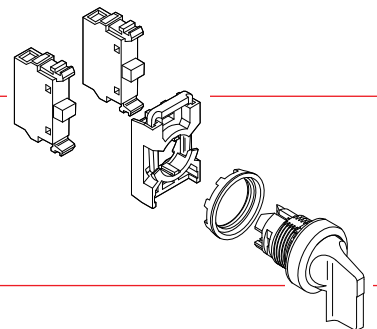

① No contact block in the center position

3-position selector switches Non-illuminated

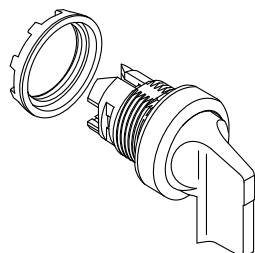
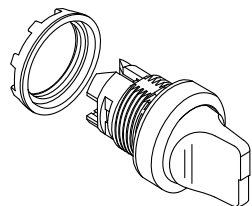

Bezel in black plastic as standard
Bezel in metal:
Replace '1' in the:
Catalog No. M3SSX-1 0X
Ref. Code 1SFA611XXX R 1XXX
3 for metal bezel

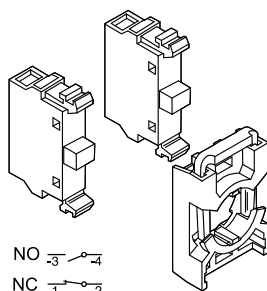

Contact functions

Block positions as seen from operator front.

Handle position	Left block	Right block
A	x	o
B	o	o
C	o	x

Operator ...

Symbol	Handle color	Catalog No.	Ref. Code	List Price
with short handle ①				
Maintained				
	Red	M3SS1-10R	1SFA 611 210 R1001	\$ 11.00
	Black	M3SS1-10B	1SFA 611 210 R1006	
	Grey	M3SS1-10U	1SFA 611 210 R1007	
Momentary, spring return from A to B and from C to B				
	Red	M3SS2-10R	1SFA 611 211 R1001	14.00
	Black	M3SS2-10B	1SFA 611 211 R1006	
	Grey	M3SS2-10U	1SFA 611 211 R1007	
Momentary, spring return from C to B				
	Red	M3SS3-10R	1SFA 611 212 R1001	14.00
	Black	M3SS3-10B	1SFA 611 212 R1006	
	Grey	M3SS3-10U	1SFA 611 212 R1007	
Momentary, spring return from A to B				
	Red	M3SS7-10R	1SFA 611 216 R1001	14.00
	Black	M3SS7-10B	1SFA 611 216 R1006	
	Grey	M3SS7-10U	1SFA 611 216 R1007	

with long handle ①

Maintained				
	Red	M3SS4-10R	1SFA 611 213 R1001	11.00
	Black	M3SS4-10B	1SFA 611 213 R1006	
	Grey	M3SS4-10U	1SFA 611 213 R1007	
Momentary, spring return from A to B and from C to B				
	Red	M3SS5-10R	1SFA 611 214 R1001	14.00
	Black	M3SS5-10B	1SFA 611 214 R1006	
	Grey	M3SS5-10U	1SFA 611 214 R1007	
Momentary, spring return from C to B				
	Red	M3SS6-10R	1SFA 611 215 R1001	14.00
	Black	M3SS6-10B	1SFA 611 215 R1006	
	Grey	M3SS6-10U	1SFA 611 215 R1007	
Momentary, spring return from A to B				
	Red	M3SS8-10R	1SFA 611 217 R1001	14.00
	Black	M3SS8-10B	1SFA 611 217 R1006	
	Grey	M3SS8-10U	1SFA 611 217 R1007	

Contact blocks and holder

Blocks	Catalog No.	Ref. Code	List Price
1 NO with holder	MCBH-10	1SFA 611 605 R1101	\$ 10.00
1 NC with holder	MCBH-01	1SFA 611 605 R1110	10.00
2 NO with holder	MCBH-20	1SFA 611 605 R1102	18.00
2 NC with holder	MCBH-02	1SFA 611 605 R1120	18.00
1 NO + 1 NC with holder	MCBH-11	1SFA 611 605 R1111	18.00
1 NO without holder	MCB-10	1SFA 611 610 R1001	8.00
1 NC without holder	MCB-01	1SFA 611 610 R1010	8.00
Holder for 3 blocks	MCBH-00	1SFA 611 605 R1100	2.00

Center position connection detail

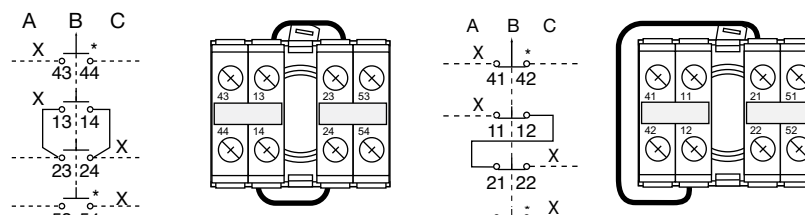

① No contact block in center position

2-position selector switches Illuminated

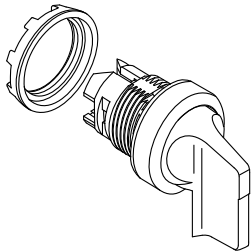
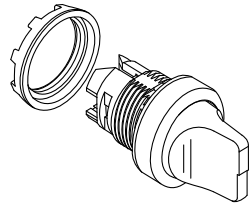

Bezel in black plastic as standard
Bezel in metal:
Replace '1' in the:
Catalog No. M2SSX-1 0X
Ref. Code 1SFA61 XXX R 1XXX
3 for metal bezel

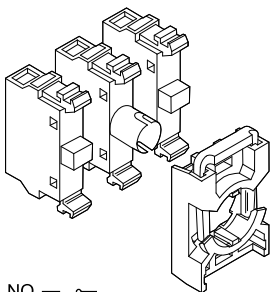

NO $\frac{3}{-}$ $\frac{4}{-}$
LB $\frac{x1}{-}$ $\frac{x2}{-}$
NC $\frac{-1}{-}$ $\frac{-2}{-}$

Operator ...

Symbol	Handle color	Catalog No.	Ref. Code	List Price
--------	--------------	-------------	-----------	------------

with short handle ①

Maintained



Red	M2SS1-11R	1SFA 611 200 R1101	\$ 17.00
Green	M2SS1-11G	1SFA 611 200 R1102	
Yellow	M2SS1-11Y	1SFA 611 200 R1103	
Blue	M2SS1-11L	1SFA 611 200 R1104	
Clear	M2SS1-11C	1SFA 611 200 R1108	

Maintained



Red	M2SS2-11R	1SFA 611 201 R1101	17.00
Green	M2SS2-11G	1SFA 611 201 R1102	
Yellow	M2SS2-11Y	1SFA 611 201 R1103	
Blue	M2SS2-11L	1SFA 611 201 R1104	
Clear	M2SS2-11C	1SFA 611 201 R1108	

Momentary, spring return from C to B



Red	M2SS3-11R	1SFA 611 202 R1101	26.00
Green	M2SS3-11G	1SFA 611 202 R1102	
Yellow	M2SS3-11Y	1SFA 611 202 R1103	
Blue	M2SS3-11L	1SFA 611 202 R1104	
Clear	M2SS3-11C	1SFA 611 202 R1108	

with long handle ①

Maintained



Red	M2SS4-11R	1SFA 611 203 R1101	17.00
Green	M2SS4-11G	1SFA 611 203 R1102	
Yellow	M2SS4-11Y	1SFA 611 203 R1103	
Blue	M2SS4-11L	1SFA 611 203 R1104	
Clear	M2SS4-11C	1SFA 611 203 R1108	

Maintained



Red	M2SS5-11R	1SFA 611 204 R1101	17.00
Green	M2SS5-11G	1SFA 611 204 R1102	
Yellow	M2SS5-11Y	1SFA 611 204 R1103	
Blue	M2SS5-11L	1SFA 611 204 R1104	
Clear	M2SS5-11C	1SFA 611 204 R1108	

Momentary, spring return from C to B



Red	M2SS6-11R	1SFA 611 205 R1101	26.00
Green	M2SS6-11G	1SFA 611 205 R1102	
Yellow	M2SS6-11Y	1SFA 611 205 R1103	
Blue	M2SS6-11L	1SFA 611 205 R1104	
Clear	M2SS6-11C	1SFA 611 205 R1108	

Contact blocks, lamp block and holder ②

Blocks	Catalog No.	Ref. Code	List Price
1 NO + 1 LB with holder	MCBH-101	1SFA 611 605 R1201	\$ 27.50
1 NC + 1 LB with holder	MCBH-011	1SFA 611 605 R1210	27.50
2 NO + 1 LB with holder	MCBH-201	1SFA 611 605 R1202	35.50
2 NC + 1 LB with holder	MCBH-021	1SFA 611 605 R1220	35.50
1 NO + 1 NC with holder	MCBH-111	1SFA 611 605 R1211	35.50
1 NO without holder	MCB-10	1SFA 611 610 R1001	8.00
1 NC without holder	MCB-01	1SFA 611 610 R1010	8.00
Lamp block for 2 W, max 230 V AC/DC bulb or LED	MLB-1	1SFA 611 620 R1001	17.50
Holder for 3 blocks	MCBH-00	1SFA 611 605 R1100	2.00

Contact functions See Page 8.12

Ordering example See Page 8.12

① No contact block in the center position, reserved for lamp block.

② Lamp block MLB-1. Bulb not included. Other lamp block see Accessories, bulb max 1.2 W.

3-position selector switches Illuminated

Pilot Devices
Modular Range
22mm

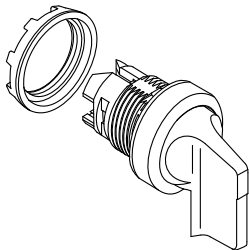
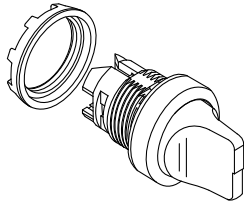

Bezel in black plastic as standard
Bezel in metal:
Replace '1' in the:
Catalog No. M3SSX-1 0X
3 for metal bezel

Center position connection detail

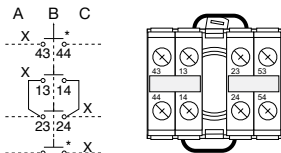

* Contacts may be N.O. or N.C.

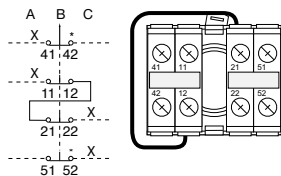

* Contacts may be N.O. or N.C.

Operator ...

Symbol	Handle color	Catalog No.	Ref. Code	List Price
with short handle ①				
Maintained				
	Red	M3SS1-11R	1SFA 611 210 R1101	\$ 17.00
	Green	M3SS1-11G	1SFA 611 210 R1102	
	Yellow	M3SS1-11Y	1SFA 611 210 R1103	
	Blue	M3SS1-11L	1SFA 611 210 R1104	
	Clear	M3SS1-11C	1SFA 611 210 R1108	
Momentary, spring return from A to B and from C to B				
	Red	M3SS2-11R	1SFA 611 211 R1101	26.00
	Green	M3SS2-11G	1SFA 611 211 R1102	
	Yellow	M3SS2-11Y	1SFA 611 211 R1103	
	Blue	M3SS2-11L	1SFA 611 211 R1104	
	Clear	M3SS2-11C	1SFA 611 211 R1108	
Momentary, spring return from C to B				
	Red	M3SS3-11R	1SFA 611 212 R1101	26.00
	Green	M3SS3-11G	1SFA 611 212 R1102	
	Yellow	M3SS3-11Y	1SFA 611 212 R1103	
	Blue	M3SS3-11L	1SFA 611 212 R1104	
	Clear	M3SS3-11C	1SFA 611 212 R1108	
Momentary, spring return from A to B				
	Red	M3SS7-11R	1SFA 611 216 R1101	26.00
	Green	M3SS7-11G	1SFA 611 216 R1102	
	Yellow	M3SS7-11Y	1SFA 611 216 R1103	
	Blue	M3SS7-11L	1SFA 611 216 R1104	
	Clear	M3SS7-11C	1SFA 611 216 R1108	
with long handle ①				
Maintained				
	Red	M3SS4-11R	1SFA 611 213 R1101	17.00
	Green	M3SS4-11G	1SFA 611 213 R1102	
	Yellow	M3SS4-11Y	1SFA 611 213 R1103	
	Blue	M3SS4-11L	1SFA 611 213 R1104	
	Clear	M3SS4-11C	1SFA 611 213 R1108	
Momentary, spring return from A to B and from C to B				
	Red	M3SS5-11R	1SFA 611 214 R1101	26.00
	Green	M3SS5-11G	1SFA 611 214 R1102	
	Yellow	M3SS5-11Y	1SFA 611 214 R1103	
	Blue	M3SS5-11L	1SFA 611 214 R1104	
	Clear	M3SS5-11C	1SFA 611 214 R1108	
Momentary, spring return from C to B				
	Red	M3SS6-11R	1SFA 611 215 R1101	26.00
	Green	M3SS6-11G	1SFA 611 215 R1102	
	Yellow	M3SS6-11Y	1SFA 611 215 R1103	
	Blue	M3SS6-11L	1SFA 611 215 R1104	
	Clear	M3SS6-11C	1SFA 611 215 R1108	
Momentary, spring return from A to B				
	Red	M3SS8-11R	1SFA 611 217 R1101	26.00
	Green	M3SS8-11G	1SFA 611 217 R1102	
	Yellow	M3SS8-11Y	1SFA 611 217 R1103	
	Blue	M3SS8-11L	1SFA 611 217 R1104	
	Clear	M3SS8-11C	1SFA 611 217 R1108	

Contact blocks, lamp block and holder See Page 8.13

Contact functions See Page 8.13

Ordering example See Page 8.13

① No contact block in the center position, reserved for lamp block.

Key-operated selector switches 2 and 3 positions

8

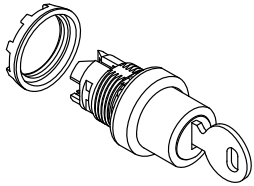
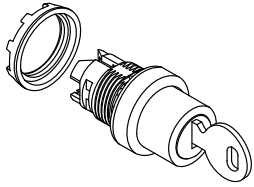

Bezel in black plastic as standard

Bezel in metal:

Replace '1' in the:

Catalog No. MXSSKX-1 0Δ

Ref. Code 1SFA6112XX R 1XXΔ

3 for metal bezel

Key codes

71 (standard) Δ = 1

72 Δ = 2

73 Δ = 3

Other (on request)

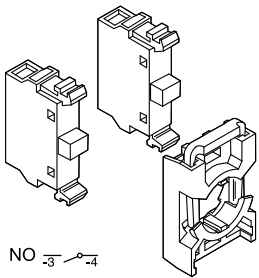

NO $\overline{3}$ - 4
NC $\overline{1}$ - 2

Operator ...

Symbol	The key can be removed in	Catalog No.	Ref. Code	List Price
2 positions ①				
	in both positions	M2SSK1-10Δ ①	1SFA 611 280 R100Δ ②	\$ 41
Maintained 	in position B only	M2SSK2-10Δ ①	1SFA 611 281 R100Δ ②	
Momentary, spring return from C to B 	in position B only	M2SSK3-10Δ ①	1SFA 611 282 R100Δ ②	
3 positions ①				
	in all positions	M3SSK1-10Δ ①	1SFA 611 283 R100Δ ②	53
Maintained 	in position B only	M3SSK2-10Δ ①	1SFA 611 284 R100Δ ②	
Momentary, spring return from A to B and from C to B 	in position B only	M3SSK3-10Δ ①	1SFA 611 285 R100Δ ②	
Momentary, spring return from C to B 	in position A only	M3SSK4-10Δ ①	1SFA 611 286 R100Δ ③	
Momentary, spring return from C to B 	in all positions	M3SSK5-10Δ ①	1SFA 611 287 R100Δ ②	

Contact blocks and holder

Blocks	Catalog No.	Ref. Code	List Price
2 NO with holder	MCBH-20	1SFA 611 605 R1102	\$ 18.00
2 NC with holder	MCBH-02	1SFA 611 605 R1120	
1 NO + 1 NC with holder	MCBH-11	1SFA 611 605 R1111	
1 NO without holder	MCB-10	1SFA 611 610 R1001	8.00
1 NC without holder	MCB-01	1SFA 611 610 R1010	8.00
Holder for 3 blocks	MCBH-00	1SFA 611 605 R1100	2.00

Contact functions

Two positions: See Page 8.12

Three positions: See Page 8.13

Ordering example

Requested: A key-operated selector switch. Three positions.

Maintained. Key removable in position B. Key code 72.

With 2 NC contacts

Ref.: 1 piece of M3SSK2-102 + 1 piece of MCBH-02

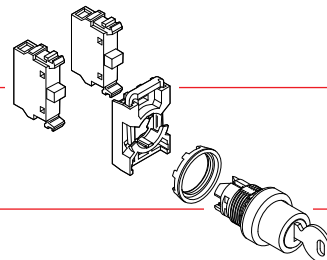

① No contact block in the center position

Toggle switches 2 and 3 positions

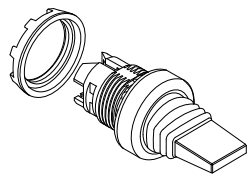

Operator

Symbol	Bezel	Catalog No.	Ref. Code	List Price
Toggle switch with 2 positions				
Maintained				
	Black plastic	MTS1-10B	1SFA 611 300 R1006	\$ 18.00
	Metal	MTS1-30B	1SFA 611 300 R 3006	

Toggle switch with 3 positions

Momentary, spring return from A to B and from C to B

	Black plastic	MTS2-10B	1SFA 611 301 R1006	18.00
	Metal	MTS2-30B	1SFA 611 301 R 3006	
Maintained				
	Black plastic	MTS3-10B	1SFA 611 302 R1006	18.00
	Metal	MTS3-30B	1SFA 611 302 R 3006	

Contact blocks and holder

Blocks	Catalog No.	Ref. Code	List Price
1 NO with holder	MCBH-10	1SFA 611 605 R1101	\$ 10.00
1 NC with holder	MCBH-01	1SFA 611 605 R1110	10.00
2 NO with holder	MCBH-20	1SFA 611 605 R1102	18.00
2 NC with holder	MCBH-02	1SFA 611 605 R1120	18.00
1 NO + 1 NC with holder	MCBH-11	1SFA 611 605 R1111	18.00
1 NO without holder	MCB-10	1SFA 611 610 R1001	8.00
1 NC without holder	MCB-01	1SFA 611 610 R1010	8.00
Holder for 3 blocks	MCBH-00	1SFA 611 605 R1100	2.00

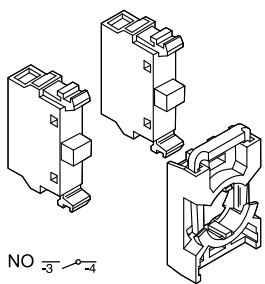

Contact block functions

Block positions as seen from operator front.

Two-position maintained switch

Handle position	Left block	Right block
A	O	O
C	x	x

O = not actuated (normal state)
x = actuated (state changed)

Three-position switch

Handle position	Left block	Middle block	Right block
A	O	x	x
B	O	O	O
C	x	x	O

O = not actuated (normal state)
x = actuated (state changed)

Center position connection detail

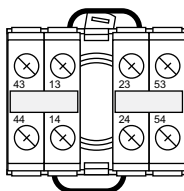
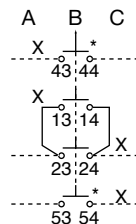

* Contacts may be N.O. or N.C.

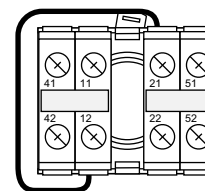
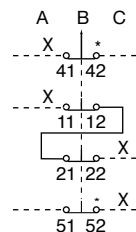

* Contacts may be N.O. or N.C.

Reset pushbuttons

Reset pushbutton without shaft

Lens Color	Text	Catalog No.	Ref. Code	List Price
With flush button				
Red	No text	KPR1-100R	1SFA 616 160 R1001	\$ 8.50
Green	No text	KPR1-100G	1SFA 616 160 R1002	8.50
	II	KPR1-103G	1SFA 616 160 R1032	8.50
Yellow	No text	KPR1-100Y	1SFA 616 160 R1003	8.50
Blue	No text	KPR1-100L	1SFA 616 160 R1004	8.50
	R	KPR1-101L	1SFA 616 160 R1014	8.50
White	No text	KPR1-100W	1SFA 616 160 R1005	8.50
	R	KPR1-101W	1SFA 616 160 R1015	8.50
	I	KPR1-102W	1SFA 616 160 R1025	8.50
	II	KPR1-103W	1SFA 616 160 R1035	8.50
Black	No text	KPR1-100B	1SFA 616 160 R1006	8.50
	RESET	KPR1-104B	1SFA 616 160 R1046	12.00
With extended button				
Red	No text	KPR2-100R	1SFA 616 161 R1001	14.00
	O	KPR2-105R	1SFA 616 161 R1051	
White	No text	KPR2-100W	1SFA 616 161 R1005	
Black	No text	KPR2-100B	1SFA 616 161 R1006	
	O	KPR2-105B	1SFA 616 161 R1056	

Reset pushbutton with 180mm shaft The shaft can be cut to desired length

Lens Color	Text	Catalog No.	Ref. Code	List Price
With flush button				
Red	No text	KPR3-100R	1SFA 616 162 R1001	\$ 10.00
Green	No text	KPR3-100G	1SFA 616 162 R1002	10.00
	II	KPR3-103G	1SFA 616 162 R1032	11.00
Yellow	No text	KPR3-100Y	1SFA 616 162 R1003	11.00
Blue	No text	KPR3-100L	1SFA 616 162 R1004	10.00
	R	KPR3-101L	1SFA 616 162 R1014	11.00
White	No text	KPR3-100W	1SFA 616 162 R1005	10.00
	R	KPR3-101W	1SFA 616 162 R1015	11.00
	I	KPR3-102W	1SFA 616 162 R1025	11.00
	II	KPR3-103W	1SFA 616 162 R1035	11.00
Black	No text	KPR3-100B	1SFA 616 162 R1006	10.00
	RESET	KPR3-104B	1SFA 616 162 R1046	14
	RESET	KPR3-104BMR	(Reset w/metal shaft)	29.00
With extended button				
Red	No text	KPR4-100R	1SFA 616 163 R1001	13.10
	O	KPR4-105R	1SFA 616 163 R1051	
White	No text	KPR4-100W	1SFA 616 163 R1005	
Black	No text	KPR4-100B	1SFA 616 163 R1006	
	O	KPR4-105B	1SFA 616 163 R1056	

Accessories

In applications with a long shaft, a flexible joint can be used to avoid damage to the shaft.

Description	Catalog No.	Ref. Code	List Price
180mm Shaft Including fixing nut	KA1-8046	1SFA 616 920 R8046	\$ 2.25
Spring joint	KA1-8047	1SFA 616 920 R8047	5.00
240mm Metal shaft Including fixing nut & foot	KA1-8046MR	—	12.00

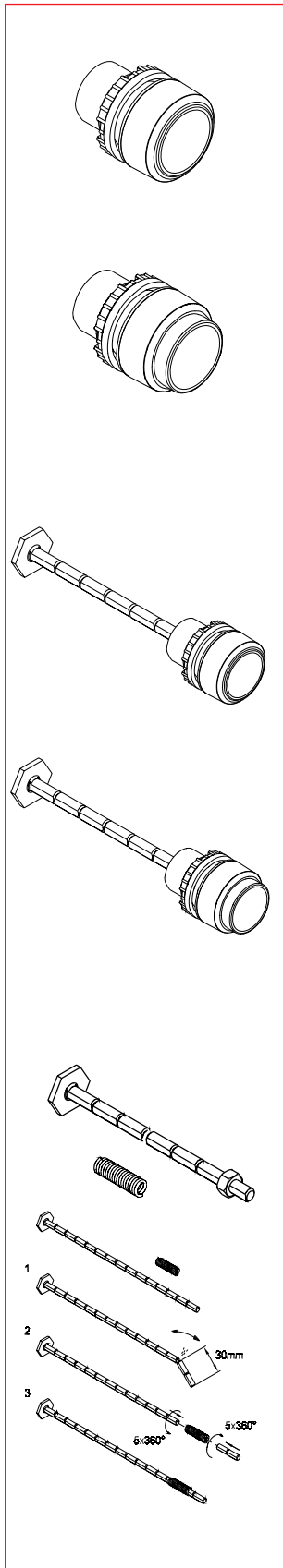

Pilot lights and Buzzers

Pilot Devices
Modular Range
22mm

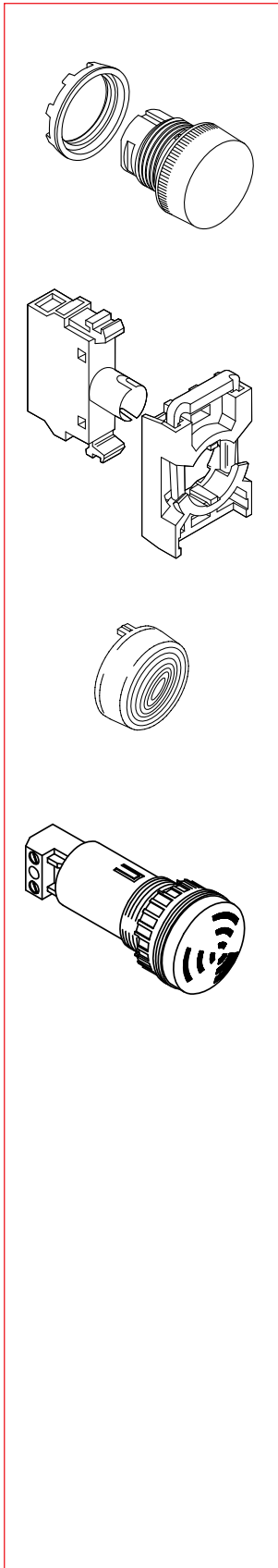

Pilot light head ①②

Lens color	Catalog No.	Ref. Code	List Price
Red	ML1-100R	1SFA 611 400 R1001	\$ 4.50
Green	ML1-100G	1SFA 611 400 R1002	
Yellow	ML1-100Y	1SFA 611 400 R1003	
Blue	ML1-100L	1SFA 611 400 R1004	
White	ML1-100W	1SFA 611 400 R1005	
Clear	ML1-100C	1SFA 611 400 R1008	

Lamp blocks with holder ①

Supply voltage	Catalog No.	Ref. Code	List Price
For max. 2 W, 230 V AC and DC filament bulb or LED $\frac{230\text{ V}, 2\text{ W}}{X1 \quad \otimes \quad X2}$ 115 V AC supply voltage. For 60 V filament bulb max. 1.2 W $\frac{115\text{ V}}{X1} \quad \text{---} \quad \frac{60\text{ V}}{1.2\text{ W}} \quad X2$ 230 V AC supply voltage. For 130 V filament bulb max. 2 W $\frac{230\text{ V}}{X1} \quad \text{---} \quad \frac{130\text{ V}}{2\text{ W}} \quad X2$	MCBH-001	1SFA 611 605 R1200	\$ 19.50
	MCBH-002	1SFA 611 605 R1300	23.50
	MCBH-003	1SFA 611 605 R1400	23.50

Light diffusing lens

To improve illumination. *Note: Cannot be used with text cap.*

Description	Catalog No.	Ref. Code	List Price
The lens is used instead of text cap	KA1-8005	1SFA 616 920 R8005	\$ 3.00

Buzzers

Black. Frequency: Approx. 2400 Hz. Loudness: Min 80 dB (A)/10 cm
Rated current: ≤ 8 mA. Service life: >5000 h

Supply voltage	Tone	Catalog No.	Catalog No.	Ref. Code	List Price
24 V AC/DC	Continuous	KB1-4010		1SFA 616 401 R4010	\$ 75.00
115 V AC/DC	Continuous	KB1-4030		1SFA 616 401 R4030	75.00
230 V AC	Continuous	KB1-4040		1SFA 616 401 R4040	75.00
24 V AC/DC	Pulsating	KB1-4110		1SFA 616 401 R4110	85.00
115 V AC/DC	Pulsating	KB1-4130		1SFA 616 401 R4130	85.00
230 V AC	Pulsating	KB1-4140		1SFA 616 401 R4140	85.00

① Bulb not included. See page 8.23

② For compact style, see page 8.33.

Potentiometers



Resistor data

Element Catalog No.	Cermet
Power rating	2 W
Mechanical angle	280°
Terminals	Solder lugs
Insulation voltage	900 V
Operating temperature	-1 – +70 °C

Complete potentiometers: screw-terminated

Black knob with integrated position indication and marking in white, no leads

Description	Catalog No.	Ref. Code	List Price
- with resistor 5 kohm			
Black plastic	MT-105B	1SFA 611 410 R1056	\$ 85.00
- with resistor 10 kohm			
Black plastic	MT-110B	1SFA 611 410 R1106	90.00

Speed potentiometers: Solder-tabs

Description	Catalog No.	Ref. Code	List Price
- with resistor 5 kohm			
Black plastic	KT-105B	1SFA 616 410 R1056	\$ 90.00
Metal	KT-305B	1SFA 616 410 R3056	95.00
- with resistor 10 kohm			
Black plastic	KT-110B	1SFA 616 410 R1106	90.00
Metal	KT-310B	1SFA 616 410 R3106	95.00

Operating knob – without resistor

Black knob with integrated position indication and marking in white.

For shaft diameter 6 - 6.35 mm.
Min. shaft length 20 mm

Description	Catalog No.	Ref. Code	List Price
Black plastic	KT-100B	1SFA 616 410 R1006	\$ 15.00
Metal	KT-300B	1SFA 616 410 R3006	20.00

Legend plates

Aluminum			
Description	Catalog No.	Ref. Code	List Price
Symbol - see figure	SK 615 562-87	SK 615 562-87	\$ 10
Scale: 0 - 10	SK 615 562-88	SK 615 562-88	

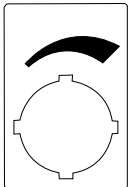

29.6 x 44.5 mm

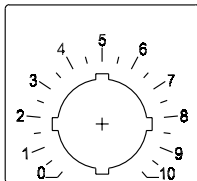

48.5 x 44.5 mm

Accessories

Pilot Devices
Modular Range
22mm

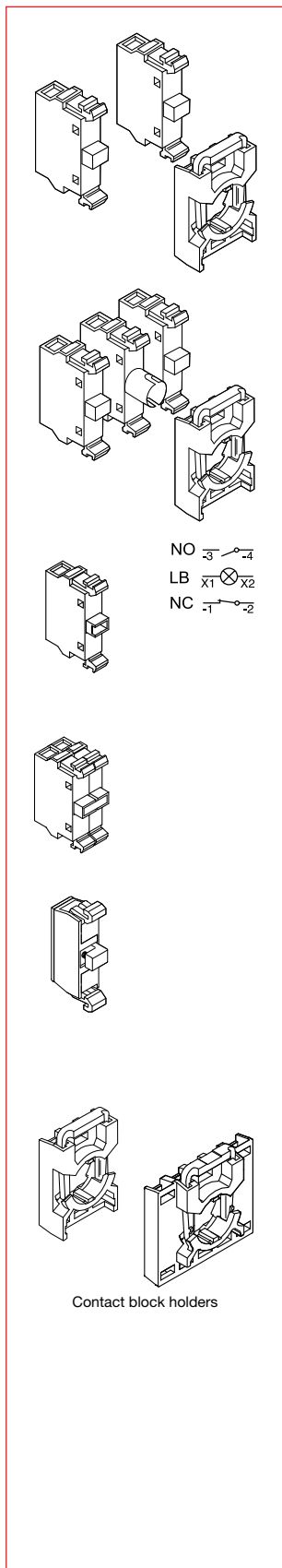

Contact blocks and lamp blocks with holder for front mounting

Max. number of blocks in holder	Included blocks	Catalog No.	Ref. Code	List Price
---------------------------------	-----------------	-------------	-----------	------------

For non-illuminated operators

3	1 NC	MCBH-01	1SFA 611 605 R1110	\$ 10.00
3	1 NO	MCBH-10	1SFA 611 605 R1101	10.00
3	2 NC	MCBH-02	1SFA 611 605 R1120	18.00
3	2 NO	MCBH-20	1SFA 611 605 R1102	18.00
3	3 NC	MCBH-03	1SFA 611 605 R1130	26.00
3	3 NO	MCBH-30	1SFA 611 605 R1103	26.00
3	1 NO + 1 NC	MCBH-11	1SFA 611 605 R1111	18.00
3	1 NO + 2 NC	MCBH-12	1SFA 611 605 R1121	26.00
3	2 NO + 1 NC	MCBH-21	1SFA 611 605 R1112	26.00

For illuminated operators

3	1 LB	MCBH-001	—	19.50
3	1 NC + 1 LB	MCBH-011	1SFA 611 605 R1210	27.50
3	1 NO + 1 LB	MCBH-101	1SFA 611 605 R1201	27.50
3	1 NO + 1 NC + 1 LB	MCBH-111	1SFA 611 605 R1211	35.50
3	2 NC + 1 LB	MCBH-021	1SFA 611 605 R1220	35.50
3	2 NO + 1 LB	MCBH-201	1SFA 611 605 R1202	35.50

Single contact blocks for front mounting

Contacts	Catalog No.	Ref. Code	List Price
1 NO	MCB-10	1SFA 611 610 R1001	\$ 8.00
1 NC	MCB-01	1SFA 611 610 R1010	8.00
1 NO with gold plated contacts	MCB-10G	1SFA 611 610 R1101	16.00
1 NC with gold plated contacts	MCB-01G	1SFA 611 610 R1110	16.00

Double contact block for front mounting

To be used together with MCBH5-00 when contact blocks in position 4- and 5- are needed.
Also when using MCBH-00 together with selector switch and contact block in position 3- is needed

Included blocks	Catalog No.	Ref. Code	List Price
2 NO	MCB-20	1SFA 611 610 R1002	\$ 16.00
2 NC	MCB-02	1SFA 611 610 R1020	
1 NO + 1 NC	MCB-11	1SFA 611 610 R1011	

Micro contact blocks for front mounting

Contacts	Catalog No.	Ref. Code	List Price
1 NO	MCBL-10	1SFA611612R1010	\$ 12
1 NC	MCBL-01	1SFA611612R1001	

Holders

Description	Catalog No.	Ref. Code	List Price
Holders for front mounting For three blocks	MCBH-00	1SFA 611 605 R1100	\$ 2.00
For five blocks	MCBH5-00	1SFA 611 601 R1100	4.00

Accessories

8

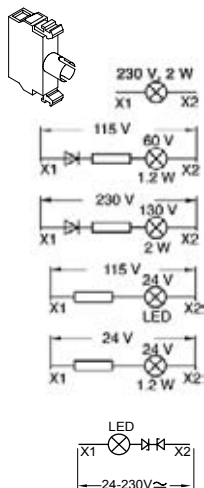

Single lamp blocks for front mounting, Ba 9s base

Description	Catalog No.	Ref. Code	List Price
For max. 2 W, 230 V AC and DC filament bulb or LED	MLB-1	1SFA 611 620 R1001	\$ 17.50
115 V AC supply voltage for 60 V filament bulb max. 1.2 W.	MLB-2	1SFA 611 620 R1002	21.50
230 V AC supply voltage for 130 V filament bulb max. 2 W	MLB-3	1SFA 611 620 R1003	21.50
115 V AC and DC supply voltage For 24 V LED	MLB-4	1SFA 611 620 R1004	21.50
24 V AC and DC supply voltage with resistor. Intended for electronic circuits. The resistor limits the making current and protects against disturbances in the electronic circuit. For 24 V filament bulb	MLB-5	1SFA 611 620 R1005	21.50
With Zener diode, max 230V AC/DC, LEDs. Used in applications where voltage interference is a problem (i.e., the LED is visibly lit although control voltage is off.	MLB-8	1SFA 611 620 R1008	19.00

Transformer blocks

For 6 or 24 V filament bulb and 24 V LED. Rated power 1.5 W.

Primary voltage	Secondary voltage	Bulb Suffix LED Filament	Catalog No.	Ref. Code	List Price
-----------------	-------------------	----------------------------	-------------	-----------	------------

With lamp holder for pilot lights, front mounting, Ba 9s base

Intended to supply a 1.2 W filament bulb.

110 - 127 V AC	6 V AC	-	T1	KTR1-1001	1SFA 616 950 R1001	\$ 35.00
220 - 250 V AC	6 V AC	-	T2	KTR1-1002	1SFA 616 950 R1002	
380 - 420 V AC	6 V AC	-	T3	KTR1-1003	1SFA 616 950 R1003	
440 - 480 V AC	6 V AC	-	T4	KTR1-1004	1SFA 616 950 R1004	
500 - 600 V AC	6 V AC	-	T5	KTR1-1005	1SFA 616 950 R1005	
110 - 127 V AC	24 V AC ①	TL1	T6	KTR1-1011	1SFA 616 950 R1011	
220 - 250 V AC	24 V AC ①	TL2	T7	KTR1-1012	1SFA 616 950 R1012	
380 - 420 V AC	24 V AC ①	TL3	T8	KTR1-1013	1SFA 616 950 R1013	
440 - 480 V AC	24 V AC ①	TL4	T9	KTR1-1014	1SFA 616 950 R1014	

For illuminated operators ②

Intended to supply a 1.2 W filament bulb mounted in lamp block MLB-1 (1SFA 611 620 R1001) only.

110 - 127V AC	6 V AC	-	T1	KTR1-2001	1SFA 616 950 R2001	35.00
220 - 250 V AC	6 V AC	-	T2	KTR1-2002	1SFA 616 950 R2002	
380 - 420 V AC	6 V AC	-	T3	KTR1-2003	1SFA 616 950 R2003	
440 - 480 V AC	6 V AC	-	T4	KTR1-2004	1SFA 616 950 R2004	
500 - 600 V AC	6 V AC	-	T5	KTR1-2005	1SFA 616 950 R2005	
110 - 127 V AC	24 V AC ①	TL1	T6	KTR1-2011	1SFA 616 950 R2011	
220 - 250 V AC	24 V AC ①	TL2	T7	KTR1-2012	1SFA 616 950 R2012	
380 - 420 V AC	24 V AC ①	TL3	T8	KTR1-2013	1SFA 616 950 R2013	
440 - 480 V AC	24 V AC ①	TL4	T9	KTR1-2014	1SFA 616 950 R2014	

Diode blocks

To be used if several lamps are to be connected to a common lamp-test pushbutton.

A diode must be connected in series with each lamp. The diode block snaps onto the lamp block or is placed at the side.

Description	Catalog No.	Ref. Code	List Price
Diode block	MDB-1001	1SFA 611 630 R1001	\$ 14.00

Diagram for lamp test with three diode block

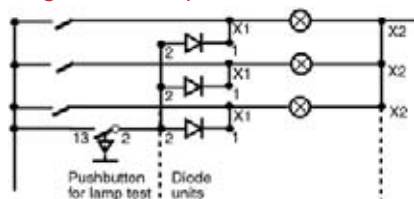

① Can be used with LED bulb

② To be used with with directly supplied lamp blocks only.

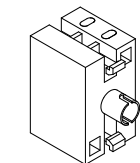

Transformer block for pilot light

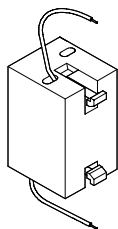

Transformer block for illuminated operator switches

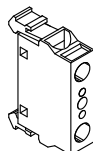

Diode block

Accessories

Pilot Devices
Modular Range
22mm

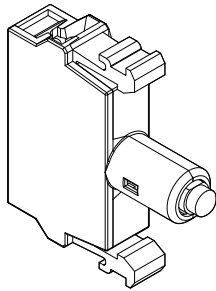

Front mounting integrated LED

Lamp block with integrated LED

With one diode chip integrated into lamp block. Choose the same color for the LED and the lamp cap or else use a clear lamp cap.

Description	Catalog No.	Ref. Code	List Price	
12V DC rated voltage				
Red	MLBL-00R	1SFA611621R1001	\$ 25.50	
Green	MLBL-00G	1SFA611621R1002		
Yellow	MLBL-00Y	1SFA611621R1003		
Blue	MLBL-00L	1SFA611621R1004		
White	MLBL-00W	1SFA611621R1005		
24V AC/DC rated voltage				
Red	MLBL-01R	1SFA611621R1011		
Green	MLBL-01G	1SFA611621R1012		
Yellow	MLBL-01Y	1SFA611621R1013		
Blue	MLBL-01L	1SFA611621R1014		
White	MLBL-01W	1SFA611621R1015		
48V AC/DC rated voltage				
Red	MLBL-02R	1SFA611621R1021		
Green	MLBL-02G	1SFA611621R1022		
Yellow	MLBL-02Y	1SFA611621R1023		
Blue	MLBL-02L	1SFA611621R1024		
White	MLBL-02W	1SFA611621R1025		
110-130V AC rated voltage				
Red	MLBL-04R	1SFA611621R1041		
Green	MLBL-04G	1SFA611621R1042		
Yellow	MLBL-04Y	1SFA611621R1043		
Blue	MLBL-04L	1SFA611621R1044		
White	MLBL-04W	1SFA611621R1045		
110-130V DC rated voltage				
Red	MLBL-05R	1SFA611621R1051		
Green	MLBL-05G	1SFA611621R1052		
Yellow	MLBL-05Y	1SFA611621R1053		
Blue	MLBL-05L	1SFA611621R1054		
White	MLBL-05W	1SFA611621R1055		
220V DC rated voltage				
Red	MLBL-06R	1SFA611621R1061		
Green	MLBL-06G	1SFA611621R1062		
Yellow	MLBL-06Y	1SFA611621R1063		
Blue	MLBL-06L	1SFA611621R1064		
White	MLBL-06W	1SFA611621R1065		
230V DC rated voltage				
Red	MLBL-07R	1SFA611621R1071		
Green	MLBL-07G	1SFA611621R1072		
Yellow	MLBL-07Y	1SFA611621R1073		
Blue	MLBL-07L	1SFA611621R1074		
White	MLBL-07W	1SFA611621R1075		

Accessories



LEDs

With one diode chip mounted on a Ba 9s base. Choose the same color for the LED and the lamp cap or else use a clear lamp cap.

For white light use white LED with clear lamp cap. At DC the lamp base have to be connected to cathode (-) and the bottom contact to anode (+).

Description				Catalog No.	Ref. Code	List Price
Color	Rated current mA	Wave-length nm	Luminance mcd			
Rated voltage 12 V, DC Service life >50 000 h						
Red	15	630	250	KA2-2011	1SFA 616 921 R2011	\$ 21.00
Green	15	525	1000	KA2-2012	1SFA 616 921 R2012	
Yellow	15	592	250	KA2-2013	1SFA 616 921 R2013	
Blue	15	470	450	KA2-2014	1SFA 616 921 R2014	
White	15	x=0.31 y=0.32	600	KA2-2015	1SFA 616 921 R2015	
Rated voltage 24 V, (AC)/DC Service life >50 000 h						
Red	15	630	250	KA2-2021	1SFA 616 921 R2021	15.00
Green	15	525	800	KA2-2022	1SFA 616 921 R2022	
Yellow	15	592	250	KA2-2023	1SFA 616 921 R2023	
Blue	15	470	400	KA2-2024	1SFA 616 921 R2024	
White	15	x=0.31 y=0.32	500	KA2-2025	1SFA 616 921 R2025	
Rated voltage 36 V, (AC)/DC Service life >50 000 h						
Red	12	630	250	KA2-2031	1SFA 616 921 R2031	21.00
Green	12	525	800	KA2-2032	1SFA 616 921 R2032	
Yellow	12	592	250	KA2-2033	1SFA 616 921 R2033	
Blue	12	470	400	KA2-2034	1SFA 616 921 R2034	
White	12	x=0.31 y=0.32	500	KA2-2035	1SFA 616 921 R2035	
Rated voltage 48 V, (AC)/DC Service life >50 000 h						
Red	12	630	200	KA2-2041	1SFA 616 921 R2041	15.00
Green	12	525	1700	KA2-2042	1SFA 616 921 R2042	
Yellow	12	592	240	KA2-2043	1SFA 616 921 R2043	
Blue	12	470	720	KA2-2044	1SFA 616 921 R2044	
White	12	x=0.31 y=0.32	1200	KA2-2045	1SFA 616 921 R2045	
Rated voltage 60 V, (AC)/DC Service life >50 000 h						
Red	10	630	160	KA2-2051	1SFA 616 921 R2051	21.00
Green	10	525	1400	KA2-2052	1SFA 616 921 R2052	
Yellow	10	592	200	KA2-2053	1SFA 616 921 R2053	
Blue	10	470	600	KA2-2054	1SFA 616 921 R2054	
White	10	x=0.31 y=0.32	1000	KA2-2055	1SFA 616 921 R2055	
Rated voltage 110-130 V, AC Service life 25 000 h						
Red	4-6	630	60-100	KA2-2131	1SFA 616 921 R2131	15.00
Green	4-6	525	500-850	KA2-2132	1SFA 616 921 R2132	
Yellow	4-6	592	70-120	KA2-2133	1SFA 616 921 R2133	
Blue	4-6	470	220-350	KA2-2134	1SFA 616 921 R2134	
White	4-6	x=0.31 y=0.32	350-600	KA2-2135	1SFA 616 921 R2135	
Rated voltage 110-130 V, AC/DC Service life 25 000 h						
Red	4-6	630	60-100	KA2-2141	1SFA 616 921 R2141	21.00
Green	4-6	525	500-850	KA2-2142	1SFA 616 921 R2142	
Yellow	4-6	592	70-120	KA2-2143	1SFA 616 921 R2143	
Blue	4-6	470	220-350	KA2-2144	1SFA 616 921 R2144	
White	4-6	x=0.31 y=0.32	350-600	KA2-2145	1SFA 616 921 R2145	
Rated voltage 230 V, AC Service life 25 000 h						
Red	4	630	60	KA2-2221	1SFA 616 921 R2221	21.00
Green	4	525	500	KA2-2222	1SFA 616 921 R2222	
Yellow	4	592	70	KA2-2223	1SFA 616 921 R2223	
Blue	4	470	220	KA2-2224	1SFA 616 921 R2224	
White	4	x=0.31 y=0.32	350	KA2-2225	1SFA 616 921 R2225	
Rated voltage 230 V, AC/DC Service life 25 000 h						
Red	4	630	60	KA2-2231	1SFA 616 921 R2221	21.00
Green	4	525	500	KA2-2232	1SFA 616 921 R2222	
Yellow	4	592	70	KA2-2233	1SFA 616 921 R2223	
Blue	4	470	220	KA2-2234	1SFA 616 921 R2224	
White	4	x=0.31 y=0.32	350	KA2-2235	1SFA 616 921 R2225	

Ⓢ At AC the luminance is decreased with 30 % and there is also a slight flickering.

Accessories

Pilot Devices
Modular Range
22mm



Filament bulb

Filament bulbs

Ba 9s base Catalog No. of current: AC/DC. A lamp changing tool is required for changing bulb.

Description					Catalog No.	Ref. Code	List Price
Rated voltage V	Rated current mA	Rated output W	Service life h	Lumiance mcd			
6	200	1.2	10 000	350	5911 086-11	5911 086-11	\$ 6.00
12	100	1.2	10 000	230	5911 086-12	5911 086-12	
24	50	1.2	10 000	280	5911 086-13	5911 086-13	
30	40	1.2	10 000	250	5911 086-4	5911 086-4	
48	42	2	6 000	500	5911 086-5	5911 086-5	
60	20	1.2	5 000	190	5911 086-14	5911 086-14	
110	18	2	7 500	250	5911 086-7	5911 086-7	
130	15	2	7 500	120	5911 086-15	5911 086-15	



Flashing LED

Flashing LED

A lamp changing tool is required for changing bulb.

Choose the same color for the LED and the lamp cap or use a clear lamp cap.

The lamp base has to be connected to cathode (-) and the bottom contact to anode (+).

Description	Catalog No.	Ref. Code	List Price
-------------	-------------	-----------	------------

**Rated voltage 24 V,
rated current 25 mA, DC**

Color	Wave length nm	Service life hours	Catalog No.	Ref. Code	List Price
Red	630	50 000	4950 512-1	4950 512-1	\$ 20.00
Green	565	50 000	4950 512-2	4950 512-2	44.25
Yellow	585	50 000	4950 512-3	4950 512-3	20.00

Accessories

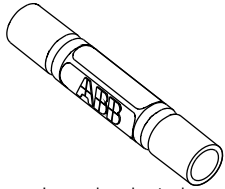

Lamp changing tool

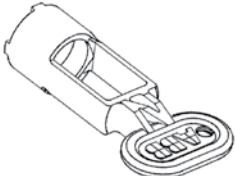

Mounting tool

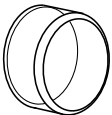

Silicone boot

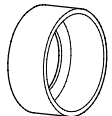

Protective ring

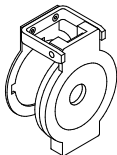

Protective cover

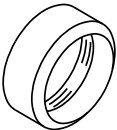

Bezel

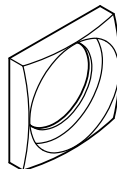

Square bezel

Lamp changing tool

Description	Catalog No.	Ref. Code	List Price
For LEDs and for bulbs	KA1-8072	1SFA 616 920 R8072	\$ 10.00

Mounting tool

Description	Catalog No.	Ref. Code	List Price
Used for tightening the sleeve	KA1-8015	1SFA 611 920 R8015	\$ 10.00

Silicone boot

Of transparent, heat and cold resistant rubber. Does not harden at low temperature. Gives IP 67 degree of protection. When membrane is used, remove the gasket.

For operator with	Catalog No.	Ref. Code	List Price
Flush button	KA1-8052	1SFA 616 920 R8052	\$ 8.00
Extended button	KA1-8002	1SFA 616 920 R8002	
Double pushbutton	MA1-8126	—	

Emergency stop shroud

For 40 mm Emergency Stop Pushbuttons; *NOT for use with plastic enclosures.*

Color	Catalog No.	Ref. Code	List Price
To prevent inadvertant operation. Yellow	KA1-8053	1SFA 616 920 R8053	\$ 16.00

Protective ring

For flush and extended buttons

Description	Catalog No.	Ref. Code	List Price
To prevent inadvertant operation. Not together with legend plate holder.	SK 615 512-1	SK 615 512-1	\$ 4.00

Protective cover

For flush button.
To prevent inadvertant operation.
Not together with legend plate holder.

Description	Catalog No.	Ref. Code	List Price
For flush button. To prevent inadvertant operation. Not together with legend plate holder.	KA1-8010	1SFA 616 920 R8010	\$ 15.00

Bezel (Packing unit 10 pieces)

Description	Catalog No.	Ref. Code	List Price
For pushbutton			
Grey, plastic	KA1-8079	1SFA 616 920 R8079	\$ 1.00
Black, plastic	KA1-8022	1SFA 616 920 R8022	1.00
Metal	KA1-8021	1SFA 616 920 R8021	2.50
For selector switch			
Grey, plastic	KA1-8077	1SFA 616 920 R8077	1.00
Black, plastic	KA1-8080	1SFA 616 920 R8080	1.00
Metal	KA1-8024	1SFA 616 920 R8024	2.50

Square bezel

Black, plastic (Packing unit 10 pieces)	SK 616 016-2	SK 616 016-2	2.00
Grey, plastic (Packing unit 10 pieces)	KA1-8124	1SFA 611 920 R8124	

Accessories

Pilot Devices
Modular Range
22mm



30mm adaptors

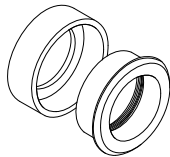

Flush-mount adaptors



Extra key

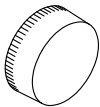

Pilot light lens



Flush buttons for pushbuttons



Extended buttons for pushbuttons

30 mm adaptors

For use when fitting the 22 mm pilot devices in 30 mm mounting holes. (1.5 – 4 mm panels)

Description	Catalog No.	Ref. Code	List Price
For use with emergency stop pushbuttons			
Black plastic	KA1-8027	1SFA 616 920 R8027	\$ 8.00
Metal	KA1-8028	1SFA 616 920 R8028	10.00
For use with pushbuttons, selector switches, pilot lights, potentiometers and buzzers			
Black plastic	KA1-8029	1SFA 616 920 R8029	8.00
Metal	KA1-8030	1SFA 616 920 R8030	10.00

Adaptors

Description	Catalog No.	Ref. Code	List Price
For flush mounted pushbuttons	KA1-8073	1SFA 616 920 R8073	\$ 15.00
For flush mounted selector switches	KA1-8074	1SFA 616 920 R8074	

Extra key (packing unit, 2 pcs)

Description	Catalog No.	Ref. Code	List Price
Ronis 455 (key code 71)	SK 616 021-71	SK 616 021-71	
Ronis 421 (key code 72)	SK 616 021-72	SK 616 021-72	\$ 10.00
Ronis 3433-E (key code 73)	SK 616 021-73	SK 616 021-73	

Lenses for pilot lights (Packing unit 10 pieces)

Description/Color	Catalog No.	Ref. Code	List Price
Red	KA1-8031	1SFA 616 920 R8031	
Green	KA1-8032	1SFA 616 920 R8032	
Yellow	KA1-8033	1SFA 616 920 R8033	\$ 2.50
Blue	KA1-8034	1SFA 616 920 R8034	
White	KA1-8035	1SFA 616 920 R8035	
Clear	KA1-8038	1SFA 616 920 R8038	
Fresnel light diffusing lens ①	KA1-8005	1SFA 616 920 R8005	3.00

Buttons for pushbuttons (Packing unit 10 pieces)

Description	Color	Catalog No.	Ref. Code	List Price
Flush, opaque	Red	KA1-8081	1SFA 616 920 R8081	
	Green	KA1-8082	1SFA 616 920 R8082	
	Yellow	KA1-8083	1SFA 616 920 R8083	
	Blue	KA1-8084	1SFA 616 920 R8084	
	White	KA1-8085	1SFA 616 920 R8085	
	Black	KA1-8086	1SFA 616 920 R8086	
	Grey	KA1-8087	1SFA 616 920 R8087	
Extended, opaque	Red	KA1-8091	1SFA 616 920 R8091	
	Green	KA1-8092	1SFA 616 920 R8092	
	Yellow	KA1-8093	1SFA 616 920 R8093	
	Blue	KA1-8094	1SFA 616 920 R8094	
	White	KA1-8095	1SFA 616 920 R8095	
	Black	KA1-8096	1SFA 616 920 R8096	
	Grey	KA1-8097	1SFA 616 920 R8097	\$ 1.50
Flush, transparent	Red	KA1-8101	1SFA 616 920 R8101	
	Green	KA1-8102	1SFA 616 920 R8102	
	Yellow	KA1-8103	1SFA 616 920 R8103	
	Blue	KA1-8104	1SFA 616 920 R8104	
	White	KA1-8105	1SFA 616 920 R8105	
	Clear	KA1-8108	1SFA 616 920 R8108	
	Extended, transparent	Red	KA1-8111	1SFA 616 920 R8111
Green		KA1-8112	1SFA 616 920 R8112	
Yellow		KA1-8113	1SFA 616 920 R8113	
Blue		KA1-8114	1SFA 616 920 R8114	
White		KA1-8115	1SFA 616 920 R8115	
Clear		KA1-8118	1SFA 616 920 R8118	

① Light diffusing insert is placed between the bulb and the lens.

Accessories

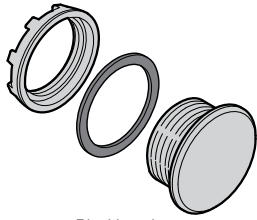

Blanking plug



Gasket



Locking nut, 22mm

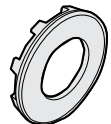

Locking nut, 30mm



Selector switch lock



Selector switch guard

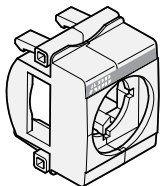

DIN rail adaptor

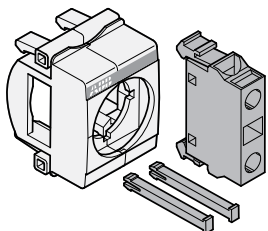

DIN Rail adaptor with accessories

Blanking plug (22mm)

Description	Catalog No.	Reference Code	List Price
Grey plastic	MA1-8129	1SFA 611 920 R8129	\$ 5.80
Black plastic	MA1-8130	1SFA 611 920 R8130	5.80

Blanking plug (30mm)

Description	Catalog No.	Reference Code	List Price
Black plastic	MA1-8133	1SFA 611 920 R8133	7.30

Spare gasket, 22mm

Description	Catalog No.	List Price
Gasket, 22mm	2152 0357-1	\$ 1.00

Locking nut – for mounting 22mm pilot devices

Description	Catalog No.	List Price	
Grey plastic, 22mm	MA1-8019	1SFA 611 920 R8019	\$ 2.00

Locking nut – for mounting 30mm adaptor with 22mm device

Description	Catalog No.	List Price	
Grey plastic, 30mm	MA1-8134	1SFA 611 920 R8134	\$ 2.50

Selector switch lock

Description	Catalog No.	List Price
Selector switch lock	CBK-XSWL	\$ 35.00

Selector switch guard

Description	Catalog No.	List Price
Selector switch guard	CBK-XSWG	\$ 8.00

DIN rail adaptor

For 35mm DIN rail. To be used with rear-mounting contact blocks. Accessories kit includes 1 dummy block and 2 connector pins. Must be used when DIN-rail mounting pilot devices with only 1 contact block.

Description	Catalog No.	Reference Code	List Price
DIN rail adaptor	MA1-8131	1SFA611920R8131	\$ 18.00
DIN rail adaptor, with accessories	MA1-8001	1SFA611920R8001	20.00
Extra dummy block, rear mount	MDB-2	1SFA611630R1002	4.00
Extra pin set	MXP3	1SFA616920R8007	3.50



Approvals

The pushbuttons, selector switches and pilot lights are approved by:
- National approval agencies: UL, CSA and China Compulsory Product Certification

For detail information please contact ABB

Standards

IEC 60947-1	Low-voltage switchgear and controlgear - Part 1: General rules
IEC 60947-5-1	Low-voltage switchgear and controlgear - Part 5-1: Control circuit devices and switching elements - Electromechanical control circuit devices
IEC 60947-5-5	Low-voltage switchgear and controlgear - Part 5-5: Control circuit devices and switching elements - Electrical emergency stop device with mechanical latching function
IEC 60073	Basic and safety principles for man-machine interface, marking and identification - Coding principles for indicators and actuators
IEC 60529	Degrees of protection provided by enclosures (IP Code)
EN418	Actuators for mechanical emergency stops
EN 60947-1	Low-voltage switchgear and controlgear - Part 1: General rules
EN 60947-5-1	Low-voltage switchgear and controlgear - Part 5-1: Control circuit devices and switching elements - Electromechanical control circuit devices
EN 60947-5-5	Low-voltage switchgear and controlgear - Part 5-5: Control circuit devices and switching elements - Electrical emergency stop device with mechanical latching function
EN 60073	Basic and safety principles for man-machine interface, marking and identification - Coding principles for indication devices and actuators
EN 60529	Degrees of protection provided by enclosures (IP Code)
EN 50013	Low-voltage switchgear and controlgear for industrial use - Terminal marking and distinctive number for particular control switches
UL 508	Industrial Control Equipment
CSA C22.2 No 14	Industrial Control Equipment

Degrees of protection – UV protection according to UL 746 (C)

Item	IP	UL/CSA
Operators		
Pushbutton with flush or extended button, MP	IP 66	Type 1, 3R, 4, 4X, 12, 13
Double pushbutton, MPD	IP 66	Type 1, 3R, 4, 4X, 12, 13
Mushroom pushbutton, momentary, MPM	IP 66	Type 1, 3R, 4, 4X, 12, 13
Emergency stop pushbutton, MPMT/P	IP 66	Type 1, 3R, 4, 4X, 12, 13
Selector switch, M2SS/M3SS	IP 66	Type 1, 3R, 4, 4X, 12, 13
Key operated selector switch, M2SSK/M3SSK	IP 66	Type 1, 3R, 4, 4X, 12
Toggle switch, MTS2/MTS3	IP 66	Type 1, 3R, 4, 4X, 12, 13
Definite purpose pushbutton, 30 mm, KP6	IP 66	Type 1, 3R, 4, 4X
Reset button, KPR	IP 66	Type 1, 3R, 4, 4X, 12, 13
Pilot lights, ML	IP 66	Type 1, 3R, 4, 4X, 12, 13
Buzzer, KB	IP 65	Type 4X
Potentiometer, KT	IP 66	Type 1, 3R, 4, 4X, 12, 13
Accessories, MA1	IP 66	Type 1, 3R, 4, 4X, 12, 13
Contact block & transformer block	IP 20	Type 1, 3R, 4, 4X, 12, 13
Enclosures		
Plastic enclosures	IP 66	Type 1, 3R, 4, 4X, 12, 13
Metallic enclosures	IP 67	Type 1, 3R, 4, 4X, 12, 13



Material

No ozone depleting substances in the products.

All front parts are made of polycarbonate

Material		
PC	Polycarbonate	High impact strength, good outdoor resistance. Can withstand light acid solutions, aliphatic hydrocarbons, paraffin, alcohols, animal and vegetable greases.
PSU	Polysulphone	Can withstand high temperatures, acids, basic solutions, alkaline compounds, oils, alcohols.
PA	Polyamide	Can withstand high temperatures, aliphatic, aromatic and chlorinated hydrocarbons, esters, ketone-aldehydes, alcohols and basic solutions.
PBT		Can withstand high temperature, aliphatic and aromatic hydrocarbons, acids, basic solutions, alcohols, grease and oils
Zinc		Good corrosion resistance in inland-, sea and industrial atmosphere.
Light-alloy		Good corrosion resistance in inland-, sea and industrial atmosphere.
Rubber		Chloroprene Nitrile

Mechanical life

Operators

Pushbuttons with flush or extended button, momentary mushroom pushbutton	2 million operations
Selector switch, maintained mushroom pushbutton, key operated selector switch and double pushbutton	0.5 million operations
Emergency stop pushbutton	0.1 million operations
Toggle switch	1 million operations
Lockable pushbuttons	0.3 million operations

Temperature

Ambient temperature during operation	-25 to +70 °C
<i>Exception: All pilot devices with 2 W continuously lit filament bulb</i>	
	-25 to +40 °C
Storage temperature	-30 to +85 °C

8

Terminals

Plus-minus Pozidriv No.2 screw with DIN-washer.	
Connectable area	min. 1 x 0.5 mm ² /AWG 20 max. 2 x 2.5 mm ² /2 x AWG14
Recommended torque	0.9 Nm

Tightening torque

Locking nut, M22	Min. 2 Nm Max. 2.3 Nm
------------------	--------------------------

Contact blocks

Mechanical endurance 10 million operations

Self cleaning contacts of silver, NC contact with positive opening.
At voltages and currents below 24 V and 5.6 mA two contact blocks in parallel are recommended. As an alternative, gold plated contacts can be used.

Ratings as per UL, CSA, NEMA	A600	Q600
	AC	DC
Rated insulation voltage	600 V	600 V
Rated thermal current	10 A	2.5 A
Rated operational current	at 120 V 6 A	at 125 V 0.55 A
	240 V 3 A	250 V 0.27 A
	480 V 1.5 A	480 V 0.10 A
	600 V 1.2 A	600 V 0.10 A

Ratings as per IEC 60 947-5-1

Rated insulation voltage, U_i	690 V
Rated thermal current, I_{th}	10 A
Rated operational current, I_e	
utilisation category AC 15,	at 120 V 8 A
	230 V 6 A
	400 V 4 A
	690 V 2 A

Rated operational current, I_e	
utilisation category DC 13,	at 24 V 5 A
	125 V 1.1 A
	250 V 0.55 A
	< 25 mΩ

Contact resistance	< 25 mΩ
Compulsory function test	at 5V, 16 mA

Max. number of contact blocks per operator ①

Pushbutton, toggle switch and mushroom pushbutton	6
Maintained pushbutton	4
Double pushbutton, selector switch, key operated selector switch and emergency stop pushbutton	4
Short circuit protection	
Max. fuse at 1 kA	16 A ordinary 10 A delayed

Lamp block

Ratings as per IEC 60 947-5-1

Rated insulation voltage	230 V
Base	Ba 9s
Permissible power, up to	2 W

Service life of filament bulb

Relative service life, luminous flux and power consumption at different service voltages.
It is generally true to say that bulbs for lower voltages give more light and have better vibration-withstand capability than bulbs for higher voltages.

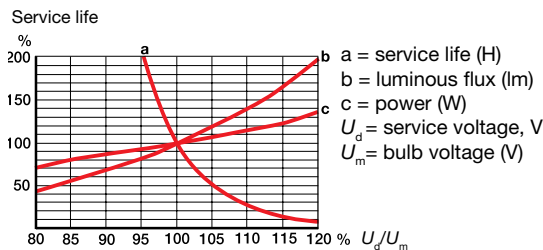

Lamp comparison

Bulb Catalog No.	Approx. life (hours)	Shock and service immunity	High vibration temperature	Low power operating	Brightness consumption
Filament	5000 - 10 000	+	+	+	+++
LED	25 000 - 50 000	+++	++	++	++

Very good +++
Good ++
Less good +

Contact blocks, cont.

Gold contacts

Ratings per UL508: 5 V, 12 mA
12 V, 1 mA

Micro block

Ratings per UL508: 125 VAC, 3 A
60 VDC, 2 A
48 VDC, 1 A

Minimum switching capacity:
3 VDC, 1 mA

Transformer block

Suitable for filament bulb 6 or 24 V AC and 1.2 W and LED 24 V.

Rated power	1.5 W
Rated voltage	Ratio, see Accessories page 8.25
Rated insulation voltage acc. to IEC 70 °C (DT)	Class E

① The contact blocks can be stacked in max. two levels on the 3- block holder.
Only one level is accepted on the 5-block holder.