

DATA SHEET

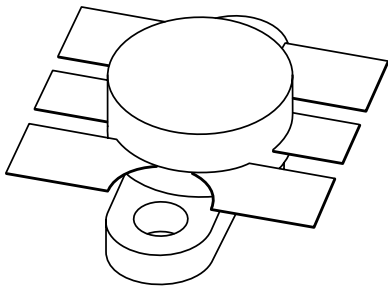

BLF346 VHF power MOS transistor

Product specification
Supersedes data of 1996 Oct 02

2003 Sep 26

VHF power MOS transistor

BLF346

FEATURES

- High power gain
- Easy power control
- Good thermal stability
- Gold metallization ensures excellent reliability.

APPLICATIONS

- Linear amplifier applications in television transmitters and transposers.

DESCRIPTION

Silicon N-channel enhancement mode vertical D-MOS transistor encapsulated in a 6-lead, SOT119A flange package, with a ceramic cap. All leads are isolated from the flange. A marking code, showing gate-source voltage (V_{GS}) information is provided for matched pair applications. Refer to the General Section of the associated Data Handbook for further information.

PINNING - SOT119A

PIN	DESCRIPTION
1	source
2	source
3	gate
4	drain
5	source
6	source

CAUTION

This product is supplied in anti-static packing to prevent damage caused by electrostatic discharge during transport and handling. For further information, refer to Philips specs.: SNW-EQ-608, SNW-FQ-302A, and SNW-FQ-302B.

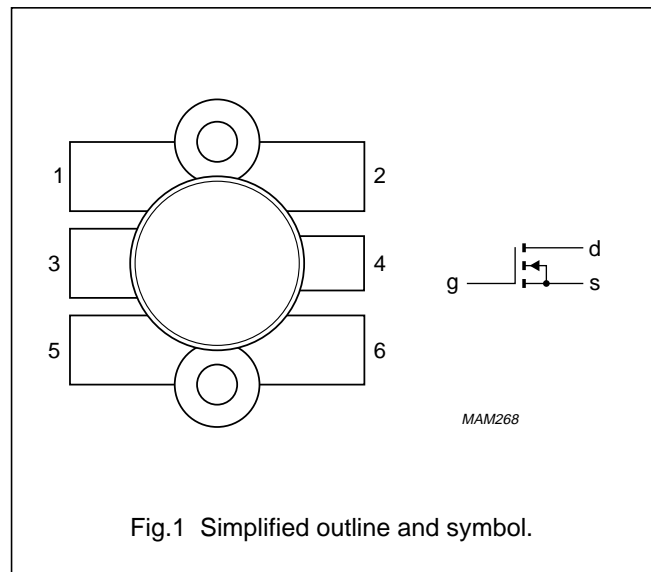

QUICK REFERENCE DATA

RF performance in a linear amplifier.

MODE OF OPERATION	f (MHz)	V_{DS} (V)	I_D (A)	T_h (°C)	P_L (W)	G_p (dB)	d_{im} (dB) ⁽¹⁾
Class-A	224.25	28	3	70	>24	>14	-52
				25	typ. 30	typ. 16.5	-52

Note

1. Three-tone test method (vision carrier -8 dB, sound carrier -7 dB, sideband signal -16 dB), zero dB corresponds to peak synchronization level.

WARNING

Product and environmental safety - toxic materials

This product contains beryllium oxide. The product is entirely safe provided that the BeO disc is not damaged. All persons who handle, use or dispose of this product should be aware of its nature and of the necessary safety precautions. After use, dispose of as chemical or special waste according to the regulations applying at the location of the user. It must never be thrown out with the general or domestic waste.

VHF power MOS transistor

BLF346

LIMITING VALUES

In accordance with the Absolute Maximum System (IEC 60134).

SYMBOL	PARAMETER	CONDITIONS	MIN.	MAX.	UNIT
V_{DS}	drain-source voltage		–	65	V
V_{GS}	gate-source voltage		–	± 20	V
I_D	drain current (DC)		–	13	A
P_{tot}	total power dissipation	$T_{mb} \leq 25\text{ }^\circ\text{C}$	–	130	W
T_{stg}	storage temperature		–65	+150	$^\circ\text{C}$
T_j	junction temperature		–	200	$^\circ\text{C}$

THERMAL CHARACTERISTICS

SYMBOL	PARAMETER	CONDITIONS	VALUE	UNIT
$R_{th\ j-mb}$	thermal resistance from junction to mounting base	$T_{mb} = 25\text{ }^\circ\text{C}; P_{tot} = 130\text{ W}$	1.35	K/W
$R_{th\ mb-h}$	thermal resistance from mounting base to heatsink	$T_{mb} = 25\text{ }^\circ\text{C}; P_{tot} = 130\text{ W}$	0.2	K/W

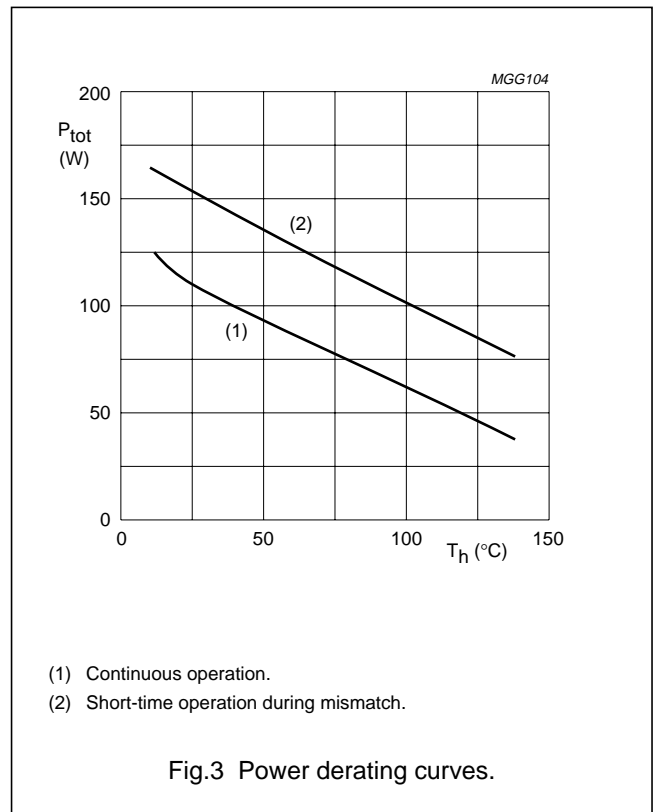
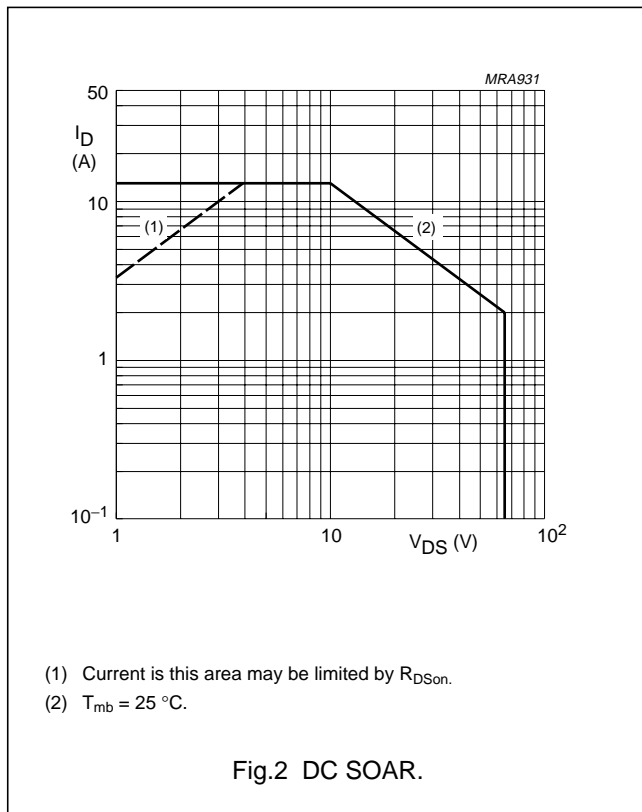

VHF power MOS transistor

BLF346

CHARACTERISTICS $T_j = 25\text{ }^\circ\text{C}$ unless otherwise specified.

SYMBOL	PARAMETER	CONDITIONS	MIN.	TYP.	MAX.	UNIT
$V_{(BR)DSS}$	drain-source breakdown voltage	$V_{GS} = 0; I_D = 50\text{ mA}$	65	–	–	V
I_{DSS}	drain-source leakage current	$V_{GS} = 0; V_{DS} = 28\text{ V}$	–	–	2.5	mA
I_{GSS}	gate-source leakage current	$V_{GS} = \pm 20\text{ V}; V_{DS} = 0$	–	–	1	μA
V_{GSth}	gate-source threshold voltage	$V_{DS} = 10\text{ V}; I_D = 50\text{ mA}$	2	–	4.5	V
ΔV_{GS}	gate-source voltage difference of matched pairs	$V_{DS} = 10\text{ V}; I_D = 50\text{ mA}$	–	–	100	mV
g_{fs}	forward transconductance	$V_{DS} = 10\text{ V}; I_D = 5\text{ A}$	3	4.2	–	S
R_{DSon}	drain-source on-state resistance	$V_{GS} = 10\text{ V}; I_D = 5\text{ A}$	–	0.2	0.3	Ω
I_{DSX}	on-state drain current	$V_{GS} = 10\text{ V}; V_{DS} = 10\text{ V}$	–	22	–	A
C_{is}	input capacitance	$V_{GS} = 0; V_{DS} = 28\text{ V}; f = 1\text{ MHz}$	–	225	–	pF
C_{os}	output capacitance	$V_{GS} = 0; V_{DS} = 28\text{ V}; f = 1\text{ MHz}$	–	180	–	pF
C_{rs}	feedback capacitance	$V_{GS} = 0; V_{DS} = 28\text{ V}; f = 1\text{ MHz}$	–	25	–	pF

 V_{GS} group indicator

GROUP	LIMITS (V)		GROUP	LIMITS (V)	
	MIN.	MAX.		MIN.	MAX.
A	2.0	2.1	O	3.3	3.4
B	2.1	2.2	P	3.4	3.5
C	2.2	2.3	Q	3.5	3.6
D	2.3	2.4	R	3.6	3.7
E	2.4	2.5	S	3.7	3.8
F	2.5	2.6	T	3.8	3.9
G	2.6	2.7	U	3.9	4.0
H	2.7	2.8	V	4.0	4.1
J	2.8	2.9	W	4.1	4.2
K	2.9	3.0	X	4.2	4.3
L	3.0	3.1	Y	4.3	4.4
M	3.1	3.2	Z	4.4	4.5
N	3.2	3.3			

VHF power MOS transistor

BLF346

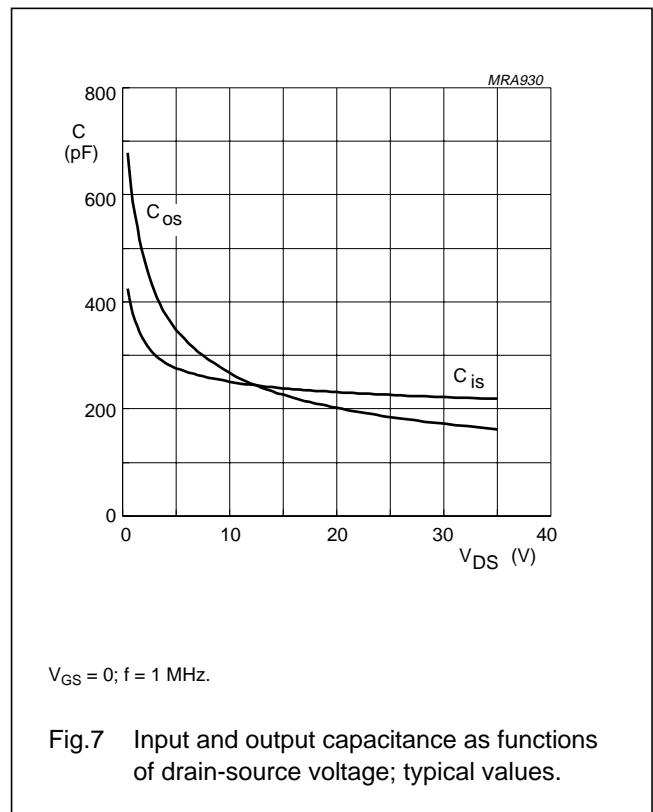
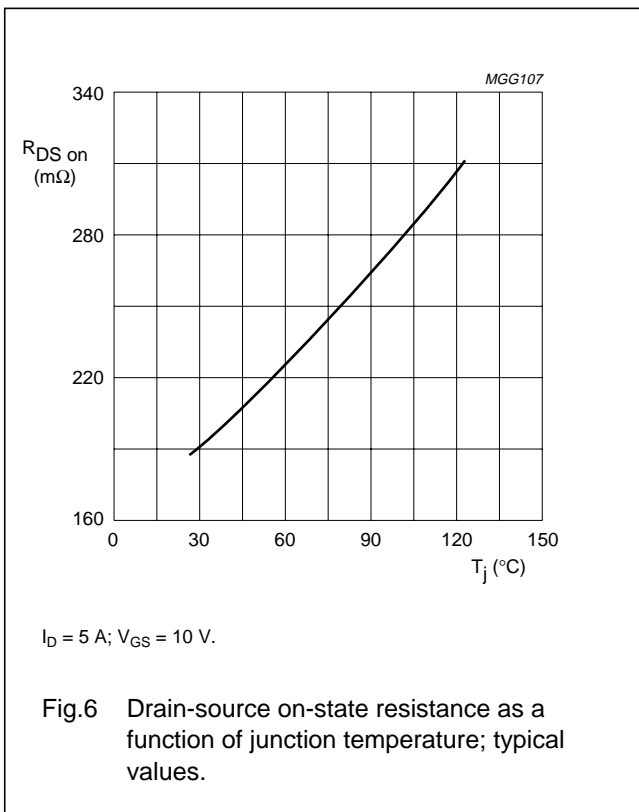
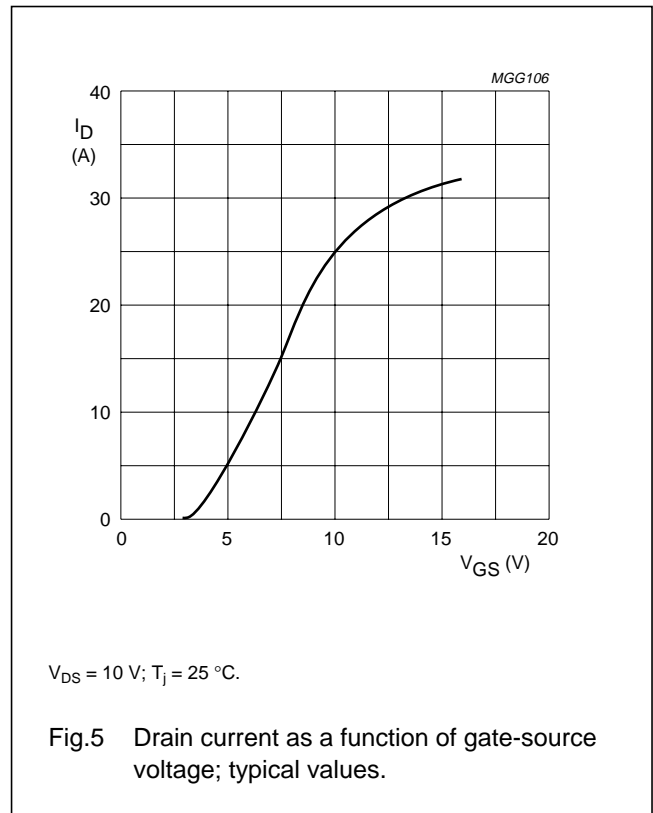
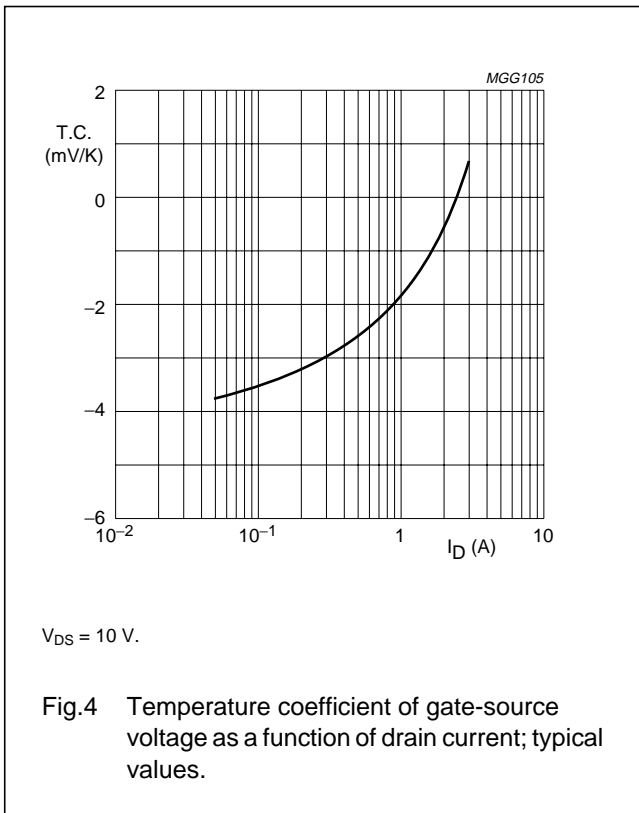

VHF power MOS transistor

BLF346

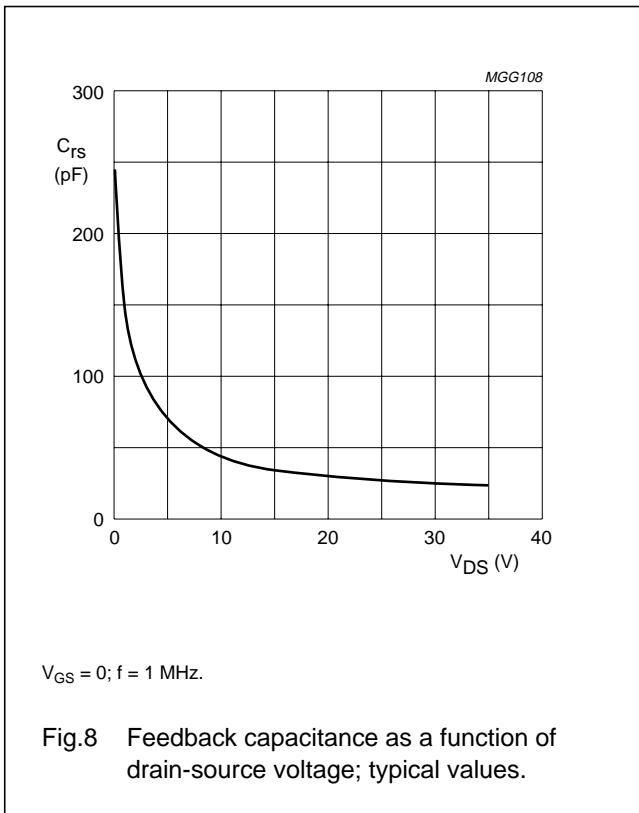

APPLICATION INFORMATION

RF performance in a linear amplifier (common source class-A circuit).

$R_{th\ mb-h} = 0.2 \text{ K/W}; Z_L = 1.1 + j0.2 \ \Omega$ unless otherwise specified.

MODE OF OPERATION	f (MHz)	V_{DS} (V)	I_D (A)	T_h (°C)	$P_{o\ sync}$ (W)	G_p (dB)	d_{im} (dB) ⁽¹⁾
Class-A	224.25	28	3	70	>24	>14	-52
				25	typ. 30	typ. 16.5	-52
				70	typ. 20	typ. 14.5	-55
				25	typ. 22	typ. 15	-55

Note

1. Three-tone test method (vision carrier -8 dB, sound carrier -7 dB, sideband signal -16 dB), zero dB corresponds to peak synchronization level.

Ruggedness in class-A operation

The BLF346 is capable of withstanding a load mismatch corresponding to $VSWR = 50 : 1$ through all phases under the following conditions: $V_{DS} = 28 \text{ V}; f = 225 \text{ MHz}$ at rated output power.

VHF power MOS transistor

BLF346

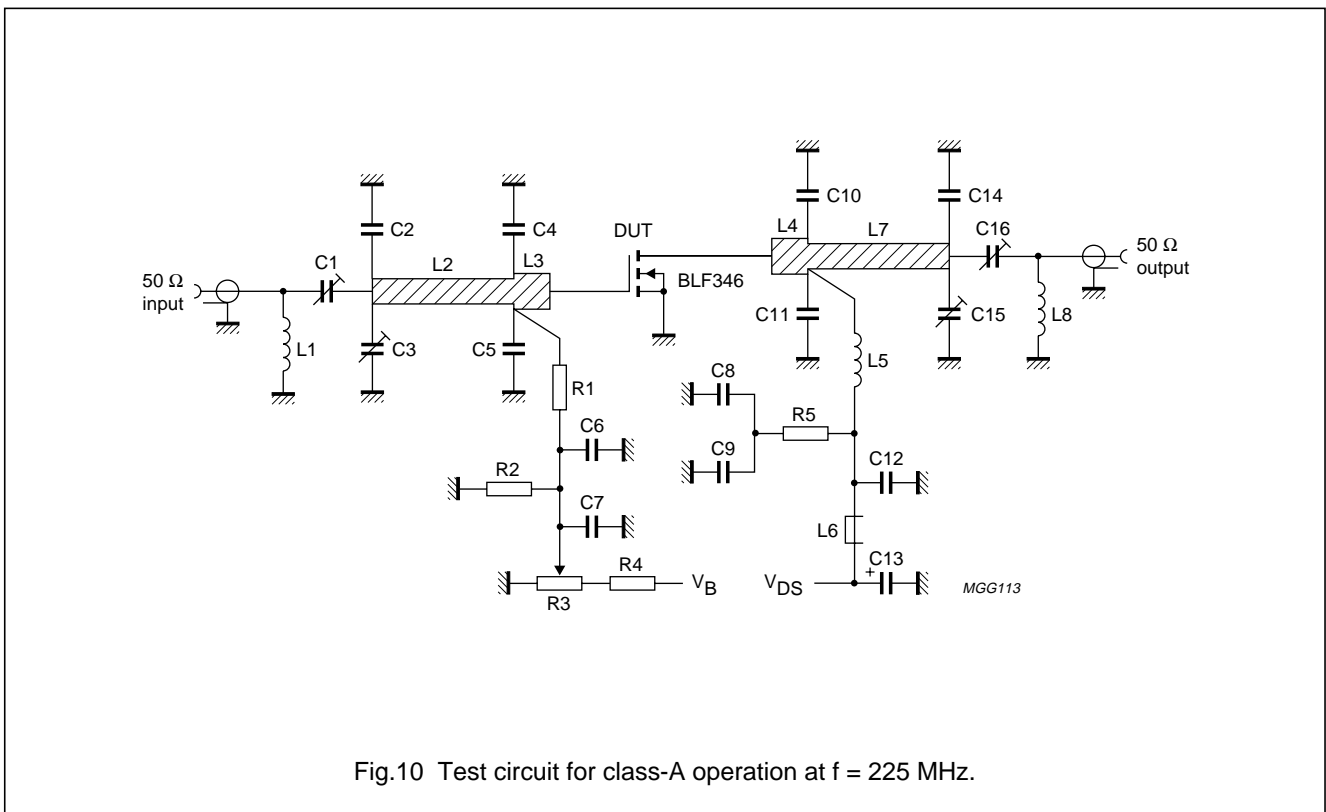
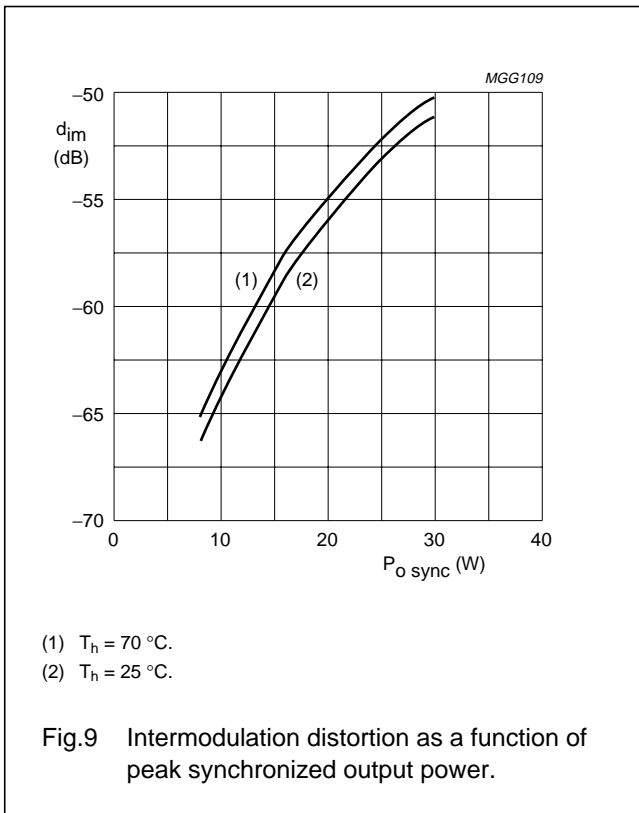

VHF power MOS transistor

BLF346

List of components (see Figs 10 and 11).

COMPONENT	DESCRIPTION	VALUE	DIMENSIONS	CATALOGUE NO.
C1	film dielectric trimmer	2 to 18 pF		2222 809 09003
C2	multilayer ceramic chip capacitor; note 1	10 pF, 500 V		
C3, C15, C16	film dielectric trimmer	4 to 40 pF		2222 809 08002
C4, C5	multilayer ceramic chip capacitor; note 1	56 pF, 500 V		
C6, C12	multilayer ceramic chip capacitor; note 1	680 pF, 500 V		
C7, C8, C9	multilayer ceramic chip capacitor	100 nF, 50 V		2222 852 47104
C10, C11	multilayer ceramic chip capacitor; note 1	43 pF, 500 V		
C13	electrolytic capacitor	10 μ F, 63 V		2222 030 38109
C14	multilayer ceramic chip capacitor; note 1	27 pF, 500 V		
L1	4 turns enamelled 0.7 mm copper wire	42.4 nH	length 4 mm; int. dia. 3 mm; leads 2 \times 5 mm	
L2	stripline; note 2	50 Ω	length 49 mm; width 2.8 mm	
L3, L4	stripline; note 2	31 Ω	length 11.5 mm; width 6 mm	
L5	2 turns enamelled 1.5 mm copper wire	18.7 nH	length 8 mm; int. dia. 4 mm; leads 2 \times 5 mm	
L6	grade 3B Ferroxcube RF choke			4312 020 36642
L7	stripline; note 2	31 Ω	length 40 mm; width 6 mm	
L8	3 turns enamelled 1.5 mm copper wire	28.8 nH	length 8 mm; int. dia. 4 mm; leads 2 \times 5 mm	
R1	metal film resistor	1 k Ω , 0.4 W		2322 151 71002
R2	metal film resistor	100 k Ω , 0.4 W		2322 151 71004
R3	10 turns cermet potentiometer	100 Ω		
R4	metal film resistor	316 k Ω , 0.4 W		2322 153 53161
R5	metal film resistor	10 Ω , 0.4 W		2322 153 51009

Notes

- American Technical Ceramics capacitor, type 100B or other capacitor of the same quality.
- The striplines are on a double copper-clad printed-circuit board with epoxy fibre-glass dielectric ($\epsilon_r = 4.5$); thickness $\frac{1}{16}$ inch.

VHF power MOS transistor

BLF346

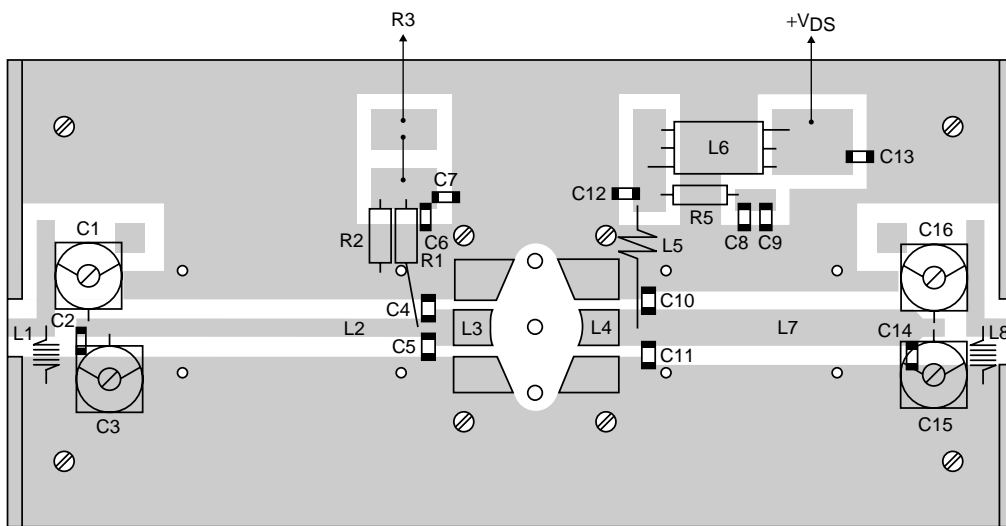
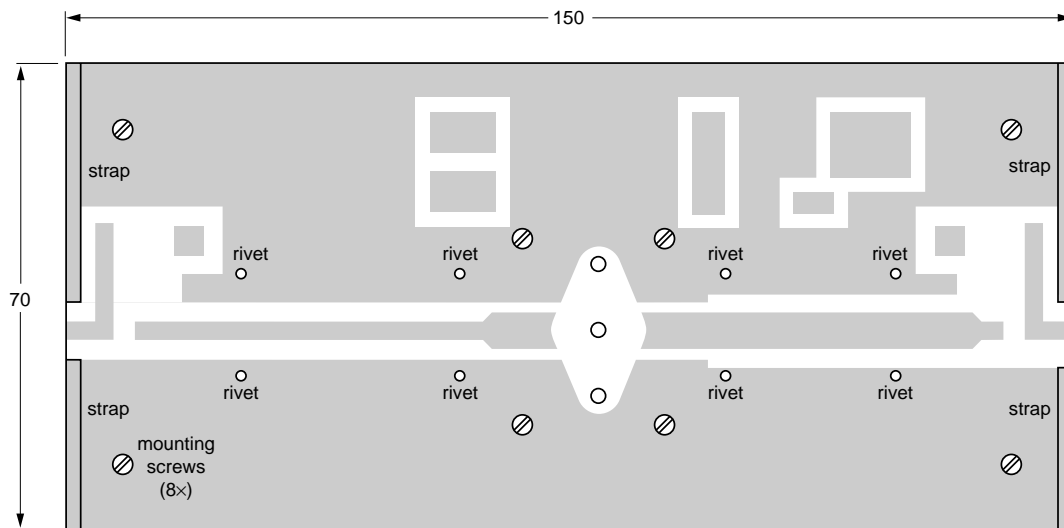

MGG114

Dimensions in mm.

The circuit and components are situated on one side of the printed-circuit board, the other side being fully metallized, to serve as a ground plane. Earth connections are made by means of copper straps and hollow rivets.

Fig.11 Component layout for 225 MHz class-A test circuit.

VHF power MOS transistor

BLF346

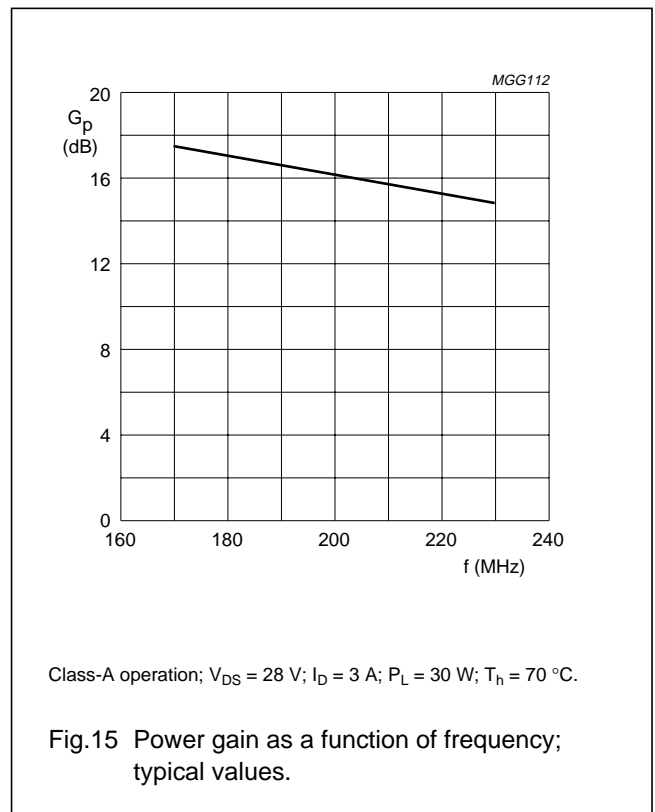
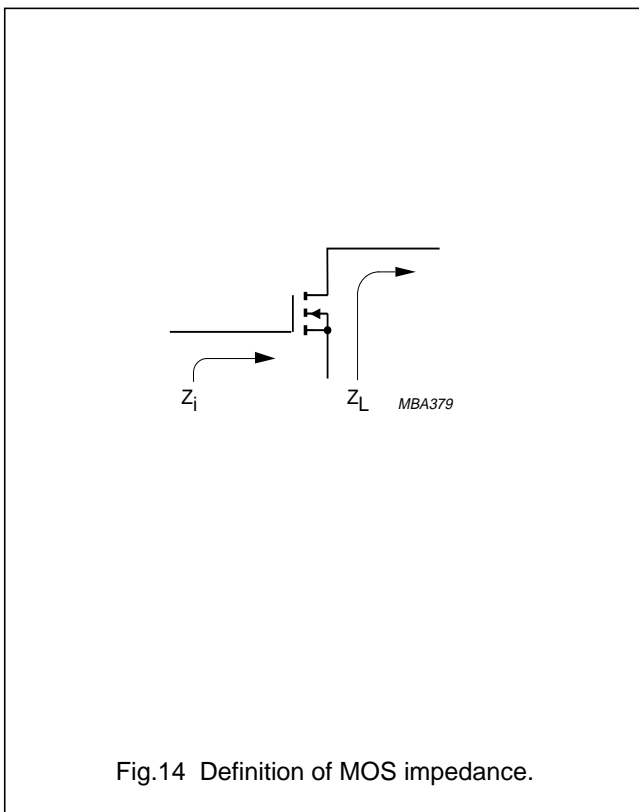
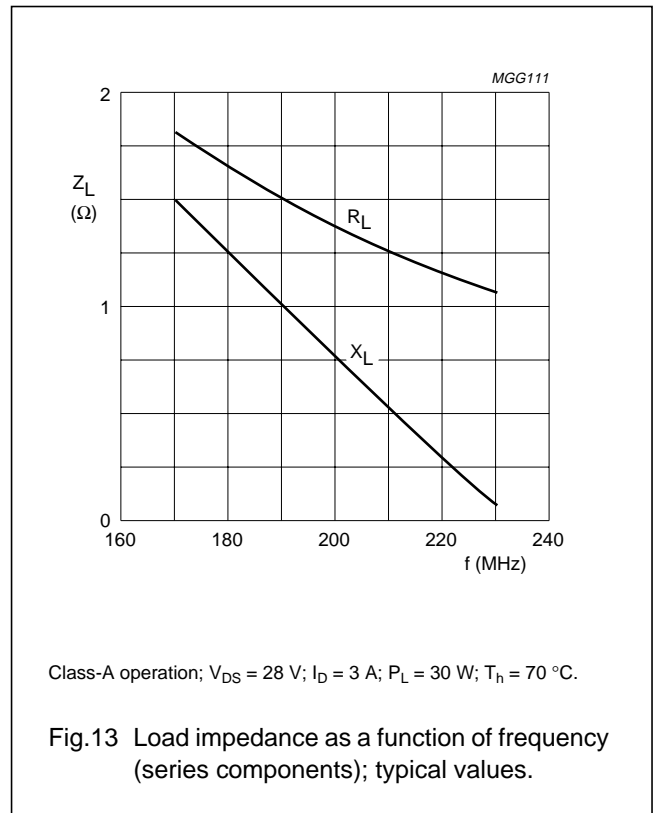
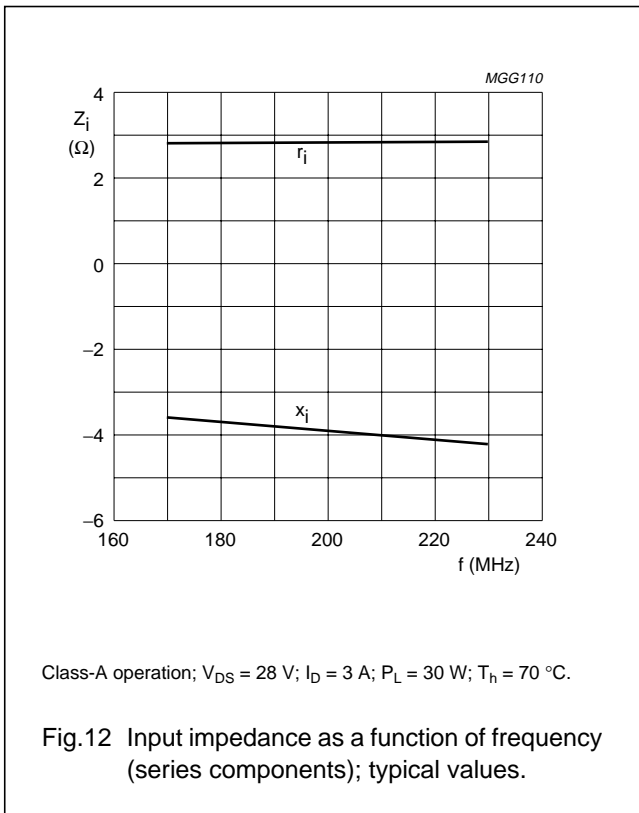

VHF power MOS transistor

BLF346

BLF346 scattering parameters $V_{DS} = 28\text{ V}$; $I_D = 3000\text{ mA}$; note 1.

f (MHz)	S ₁₁		S ₂₁		S ₁₂		S ₂₂	
	S ₁₁	∠ Φ	S ₂₁	∠ Φ	S ₁₂	∠ Φ	S ₂₂	∠ Φ
100	0.91	-178.9	2.12	67.7	0.01	-0.6	0.88	-177.3
105	0.91	-179.0	2.01	66.6	0.01	-0.4	0.88	-177.4
110	0.92	-179.1	1.91	65.5	0.01	-0.1	0.88	-177.4
115	0.92	-179.2	1.81	64.5	0.01	0.2	0.88	-177.4
120	0.92	-179.3	1.72	63.5	0.01	0.5	0.89	-177.4
130	0.92	-179.5	1.56	61.5	0.01	1.3	0.89	-177.5
140	0.92	-179.7	1.43	59.6	0.01	2.5	0.89	-177.5
150	0.93	-179.9	1.31	58.0	0.01	4.1	0.90	-177.6
160	0.93	180.0	1.21	56.3	0.01	6.0	0.90	-177.7
170	0.93	179.8	1.12	54.7	0.01	8.2	0.90	-177.8
180	0.93	179.5	1.04	53.0	0.01	10.5	0.91	-177.9
190	0.93	179.3	0.97	51.2	0.01	13.0	0.91	-178.0
200	0.94	179.1	0.91	49.6	0.01	15.7	0.91	-178.1
225	0.94	178.5	0.77	46.1	0.01	23.9	0.92	-178.5
250	0.95	178.0	0.66	43.3	0.01	33.6	0.93	-178.9
275	0.95	177.4	0.58	40.1	0.01	43.6	0.94	-179.3
300	0.95	176.7	0.50	37.5	0.01	51.8	0.94	-179.7
350	0.96	175.5	0.40	33.5	0.01	65.7	0.95	179.4
400	0.97	174.8	0.32	30.6	0.01	74.5	0.96	178.4
450	0.97	173.6	0.27	27.7	0.01	80.0	0.97	177.4
500	0.98	172.5	0.22	25.8	0.02	83.0	0.97	176.4
600	0.99	170.3	0.16	24.0	0.02	86.7	0.98	174.6
700	1.00	168.2	0.13	24.7	0.03	88.5	0.99	172.8
800	1.05	165.0	0.10	27.6	0.03	90.1	0.99	170.9
900	1.03	158.5	0.09	31.5	0.04	91.0	1.00	168.9
1000	1.00	156.6	0.08	38.7	0.04	92.1	1.00	167.1

Note

- For more extensive s-parameters see internet:
<http://www.semiconductors.philips.com/markets/communications/wirelesscommunications/broadcast>

VHF power MOS transistor

BLF346

PACKAGE OUTLINE

Flanged ceramic package; 2 mounting holes; 6 leads

SOT119A

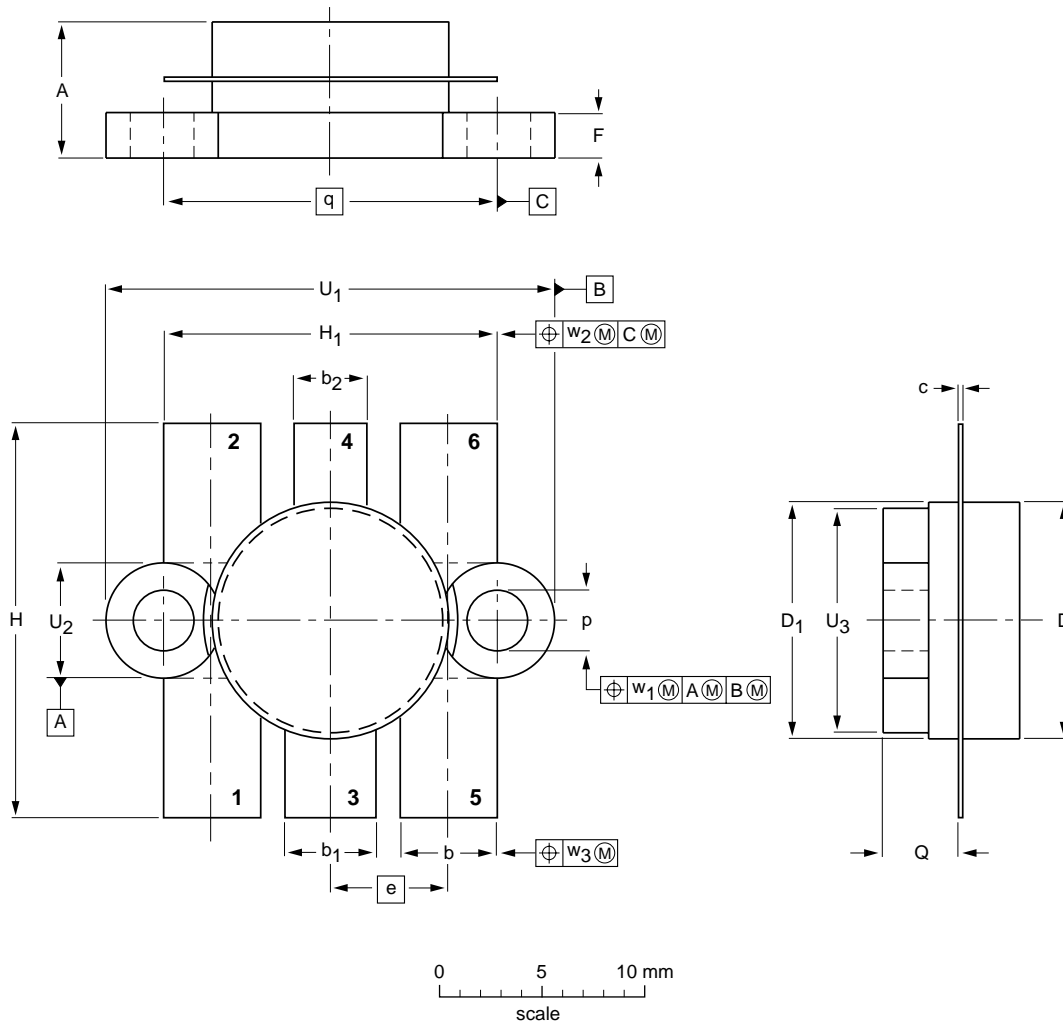

DIMENSIONS (millimetre dimensions are derived from the original inch dimensions)

UNIT	A	b	b ₁	b ₂	c	D	D ₁	e	F	H	H ₁	p	Q	q	U ₁	U ₂	U ₃	w ₁	w ₂	w ₃
mm	7.39 6.32	5.59 5.33	5.34 5.08	4.07 3.81	0.15 0.10	12.86 12.59	12.83 12.57	6.48	2.54 2.29	21.97 21.21	18.55 18.28	3.30 3.05	4.57 4.06	18.42	24.89 24.64	6.48 6.22	12.32 12.07	0.25	0.51	0.25
inches	0.291 0.249	0.220 0.210	0.210 0.200	0.160 0.150	0.006 0.004	0.505 0.496	0.505 0.495	0.255	0.100 0.090	0.865 0.835	0.730 0.720	0.130 0.120	0.180 0.160	0.725	0.980 0.970	0.255 0.245	0.485 0.475	0.010	0.020	0.010

OUTLINE VERSION	REFERENCES				EUROPEAN PROJECTION	ISSUE DATE
	IEC	JEDEC	EIAJ			
SOT119A						99-03-29

VHF power MOS transistor

BLF346

DATA SHEET STATUS

LEVEL	DATA SHEET STATUS ⁽¹⁾	PRODUCT STATUS ⁽²⁾⁽³⁾	DEFINITION
I	Objective data	Development	This data sheet contains data from the objective specification for product development. Philips Semiconductors reserves the right to change the specification in any manner without notice.
II	Preliminary data	Qualification	This data sheet contains data from the preliminary specification. Supplementary data will be published at a later date. Philips Semiconductors reserves the right to change the specification without notice, in order to improve the design and supply the best possible product.
III	Product data	Production	This data sheet contains data from the product specification. Philips Semiconductors reserves the right to make changes at any time in order to improve the design, manufacturing and supply. Relevant changes will be communicated via a Customer Product/Process Change Notification (CPCN).

Notes

1. Please consult the most recently issued data sheet before initiating or completing a design.
2. The product status of the device(s) described in this data sheet may have changed since this data sheet was published. The latest information is available on the Internet at URL <http://www.semiconductors.philips.com>.
3. For data sheets describing multiple type numbers, the highest-level product status determines the data sheet status.

DEFINITIONS

Short-form specification — The data in a short-form specification is extracted from a full data sheet with the same type number and title. For detailed information see the relevant data sheet or data handbook.

Limiting values definition — Limiting values given are in accordance with the Absolute Maximum Rating System (IEC 60134). Stress above one or more of the limiting values may cause permanent damage to the device. These are stress ratings only and operation of the device at these or at any other conditions above those given in the Characteristics sections of the specification is not implied. Exposure to limiting values for extended periods may affect device reliability.

Application information — Applications that are described herein for any of these products are for illustrative purposes only. Philips Semiconductors make no representation or warranty that such applications will be suitable for the specified use without further testing or modification.

DISCLAIMERS

Life support applications — These products are not designed for use in life support appliances, devices, or systems where malfunction of these products can reasonably be expected to result in personal injury. Philips Semiconductors customers using or selling these products for use in such applications do so at their own risk and agree to fully indemnify Philips Semiconductors for any damages resulting from such application.

Right to make changes — Philips Semiconductors reserves the right to make changes in the products - including circuits, standard cells, and/or software - described or contained herein in order to improve design and/or performance. When the product is in full production (status 'Production'), relevant changes will be communicated via a Customer Product/Process Change Notification (CPCN). Philips Semiconductors assumes no responsibility or liability for the use of any of these products, conveys no licence or title under any patent, copyright, or mask work right to these products, and makes no representations or warranties that these products are free from patent, copyright, or mask work right infringement, unless otherwise specified.

Philips Semiconductors – a worldwide company

Contact information

For additional information please visit <http://www.semiconductors.philips.com>. Fax: +31 40 27 24825

For sales offices addresses send e-mail to: sales.addresses@www.semiconductors.philips.com.

© Koninklijke Philips Electronics N.V. 2003

SCA75

All rights are reserved. Reproduction in whole or in part is prohibited without the prior written consent of the copyright owner.

The information presented in this document does not form part of any quotation or contract, is believed to be accurate and reliable and may be changed without notice. No liability will be accepted by the publisher for any consequence of its use. Publication thereof does not convey nor imply any license under patent- or other industrial or intellectual property rights.

Printed in The Netherlands

613524/05/pp14

Date of release: 2003 Sep 26

Document order number: 9397 750 11601

Let's make things better.

**Philips
Semiconductors**



PHILIPS